

SHAPES

by

DUNE



SHAPES  
by  
DUNE

# SHAPES

CONCEPT

La colección SHAPES de DUNE surge para ahondar en la exploración de los contornos y los volúmenes. Inspirada en la moda, la edificación y la propia naturaleza. SHAPES se sumerge en el estudio de las líneas, tanto rectas como orgánicas, para desarrollar un producto con la geometría como protagonista.

La versatilidad de las piezas de esta colección, al disponerlas en diferentes posiciones o combinarlas entre sí, otorga un sinfín de posibilidades. Las paredes se convierten en lienzos en blanco donde arquitectos e interioristas pueden crear sus combinaciones jugando con las formas y los relieves.

Las composiciones proporcionales ó asimétricas que resultan de la distribución de las piezas, aportan distinción y un marcado carácter estético a los proyectos.

Un mundo de oportunidades para la creación de espacios exclusivos y únicos.

*The SHAPES collection by DUNE arises to deepen the exploration of outlines and volumes. Inspired by fashion, building and nature itself. SHAPES is immersed in the study of lines, both straight and organic, to develop a product with geometry as the protagonist.*

*The versatility of the pieces of this collection, when placed in different positions or combined with each other, provides endless possibilities.*

*The walls become blank canvases where architects and interior designers can create their own combinations by playing with shapes and reliefs.*

*Proportional or asymmetric compositions resulting from the distribution of pieces, bring a distinctive and strong aesthetic character to the projects.*

*A world of opportunities to create exclusive and unique spaces.*

La inspiración surge de las formas del ORIGAMI, antiguo arte japonés que, a base de pliegues, logra que el papel adopte las formas más creativas y variadas, transmitiendo calma y paciencia a quien lo practica. Esta colección consta de tres tonalidades mate: Blanco, Negro y Gris; una brillo: Blanco; y una metalizada: Bronzo.

Cuenta con dos relieves en PVD Oro (Origami y Japan) y dos en PVD Plata (Kioto y Multishapes) que, bien solos o complementando a los acabados Blanco, Negro y Gris, aportan un toque muy sofisticado. A cada uno de los relieves se le ha aplicado un juego de texturas en pasta de vidrio y se ha recubierto con PVD, potenciando el contraste del fondo mate con el brillo de la pasta de vidrio.

*The inspiration arises from the forms of ORIGAMI, the ancient japanese art of paper folding, in which paper is folded into the most creative and varied shapes imparting those who practice it with calm and patience. This collection consists of three matt tones: White, Black and Gray; a gloss tone: White; and a metallic one: Bronze.*

*It also includes two reliefs in PVD Gold (Origami and Japan) and two in PVD Silver (Kyoto and Multishapes) which, either alone or in combination with the White, Black and Grey finishes, provide a very sophisticated touch. A texture in pâte-de-verre is applied to each of the reliefs and they are coated with PVD, highlighting the contrast between the matt background and the pâte-de-verre.*



# #1

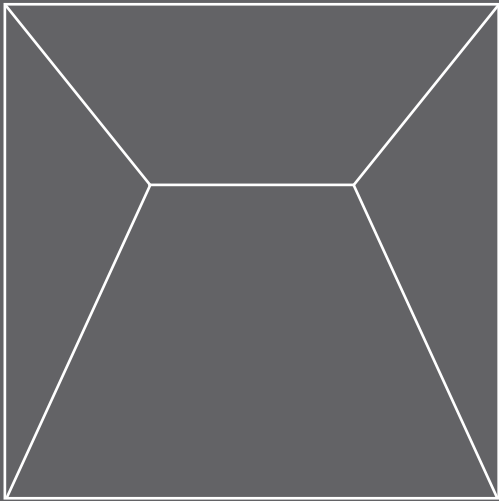

japan

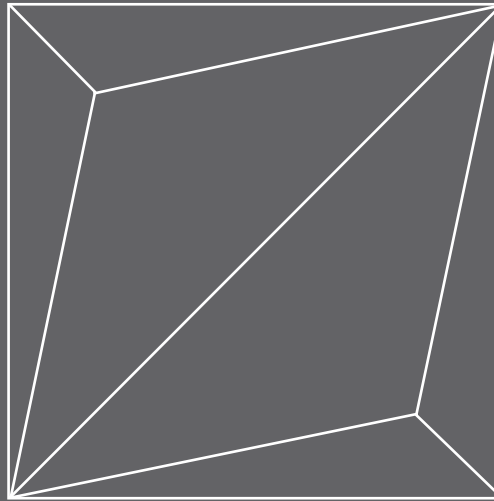

origami

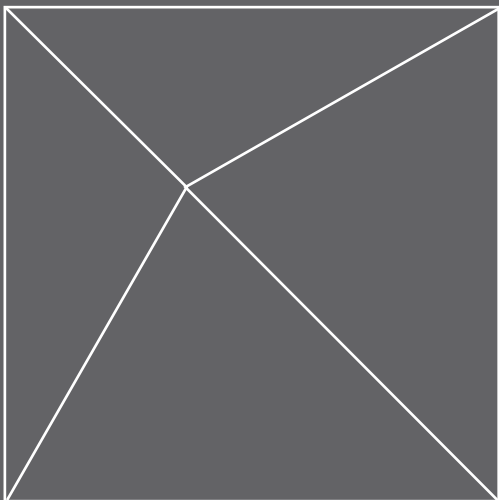

kioto

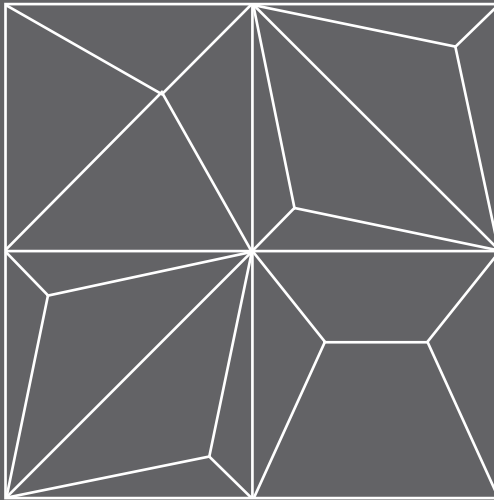

multishapes



white gloss



white

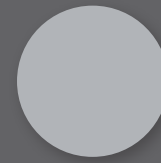

smoke



black



bronzo



silver



gold

# SHAPES #1

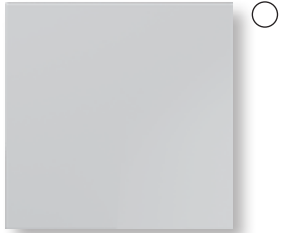

187331 Shapes White Gloss  
25x25 cm./9.8"x9.8" **M914**  
9 mm. de espesor/thickness



187345 Origami White Gloss  
25x25 cm./9.8"x9.8" **M941**  
9 mm. de espesor/thickness



187341 Japan White Gloss  
25x25 cm./9.8"x9.8" **M941**  
9 mm. de espesor/thickness



187337 Kioto White Gloss  
25x25 cm./9.8"x9.8" **M941**  
9 mm. de espesor/thickness



187349 Multishapes White Gloss  
25x25 cm./9.8"x9.8" **M941**  
9 mm. de espesor/thickness

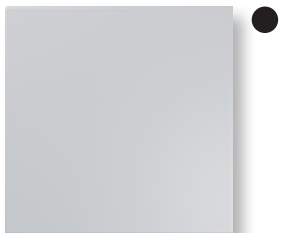

187328 Shapes White  
25x25 cm./9.8"x9.8" **M914**  
9 mm. de espesor/thickness



187342 Origami White  
25x25 cm./9.8"x9.8" **M941**  
9 mm. de espesor/thickness



187338 Japan White  
25x25 cm./9.8"x9.8" **M941**  
9 mm. de espesor/thickness



187334 Kioto White  
25x25 cm./9.8"x9.8" **M941**  
9 mm. de espesor/thickness



187346 Multishapes White  
25x25 cm./9.8"x9.8" **M941**  
9 mm. de espesor/thickness

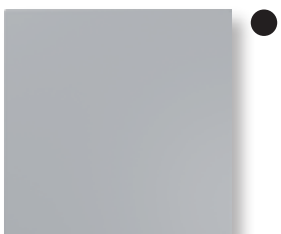

187330 Shapes Smoke  
25x25 cm./9.8"x9.8" **M914**  
9 mm. de espesor/thickness

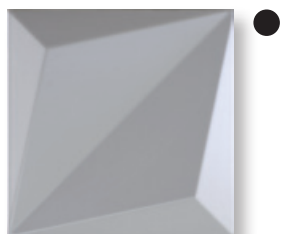

187344 Origami Smoke  
25x25 cm./9.8"x9.8" **M941**  
9 mm. de espesor/thickness

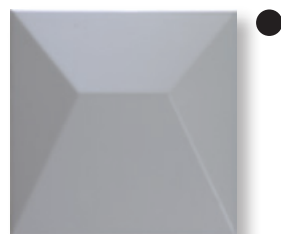

187340 Japan Smoke  
25x25 cm./9.8"x9.8" **M941**  
9 mm. de espesor/thickness



187336 Kioto Smoke  
25x25 cm./9.8"x9.8" **M941**  
9 mm. de espesor/thickness



187348 Multishapes Smoke  
25x25 cm./9.8"x9.8" **M941**  
9 mm. de espesor/thickness





187329 Shapes Black  
25x25 cm./9.8"x9.8" M914  
9 mm. de espesor/thickness



187343 Origami Black  
25x25 cm./9.8"x9.8" M941  
9 mm. de espesor/thickness

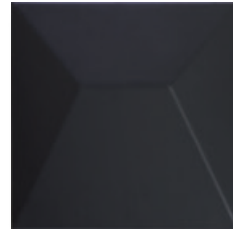

187339 Japan Black  
25x25 cm./9.8"x9.8" M941  
9 mm. de espesor/thickness



187335 Kioto Black  
25x25 cm./9.8"x9.8" M941  
9 mm. de espesor/thickness

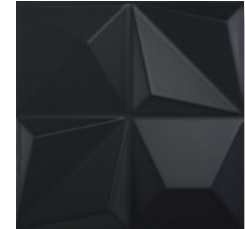

187347 Multishapes Black  
25x25 cm./9.8"x9.8" M941  
9 mm. de espesor/thickness



187424 Shapes Bronzo  
25x25 cm./9.8"x9.8" M941  
9 mm. de espesor/thickness



187485 Origami Bronzo  
25x25 cm./9.8"x9.8" M963  
9 mm. de espesor/thickness



187487 Japan Bronzo  
25x25 cm./9.8"x9.8" M963  
9 mm. de espesor/thickness



187486 Kioto Bronzo  
25x25 cm./9.8"x9.8" M963  
9 mm. de espesor/thickness



187488 Multishapes Bronzo  
25x25 cm./9.8"x9.8" M963  
9 mm. de espesor/thickness

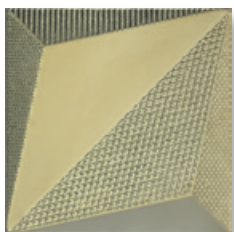

187350 Origami Gold  
25x25 cm./9.8"x9.8" D659  
9 mm. de espesor/thickness

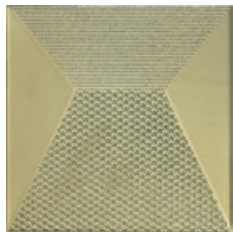

187351 Japan Gold  
25x25 cm./9.8"x9.8" D659  
9 mm. de espesor/thickness



187352 Kioto Silver  
25x25 cm./9.8"x9.8" D659  
9 mm. de espesor/thickness

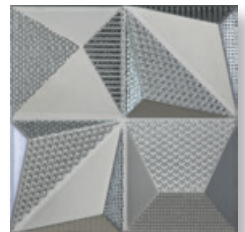

187353 Multishapes Silver  
25x25 cm./9.8"x9.8" D659  
9 mm. de espesor/thickness

-  Producto delicado / *Delicate product*
-  Aplicación metálica PVD / *Metalic application PVD*
-  Acabado Brillo/*Glossy Finish*
-  Acabado Mate/*Matt Finish*
-  Acabado Satinado ó Mix Brillo-Mate / *Satin Finish or Mix Glossy-Mat*



Japan



Japan. Este relieve debe su nombre al lugar de inspiración de la colección. Posee una forma piramidal, aunque el vértice de la pirámide ha sido truncado. Su forma nos recuerda a los tejados de los santuarios y templos Japoneses.

*Japan. This relief owes its name to the place of inspiration of the collection. It has a pyramidal shape, although the vertex of the pyramid has been truncated. Its shape reminds us of the roofs of Japanese shrines and temples.*









Origami. La simetría de este relieve surcado por una diagonal, emula las formas que adopta el papel cuando se crea con él.  
*Origami. The symmetry of this relief marked by a diagonal line, emulates the shapes that the paper adopts when folded.*

Origami









EVE  
LOVE  
FACE  
JOY



Kioto



Kioto. La capital cultural de Japón da nombre a este relieve con forma piramidal. Una pirámide cuyo vértice ha sido desplazado.  
Kioto. This relief, with pyramidal shape, is named after the cultural capital of Japan. A pyramid whose vertex has been displaced.







Multishapes. Es una miniatura de los cuatro relieves: dos módulos ORIGAMI, un módulo JAPAN y otro KIOTO.

*Multishapes. This is a combination of miniature versions of the 3 main relieves: two ORIGAMI modules, one JAPAN module and one KIOTO module.*

Multishapes

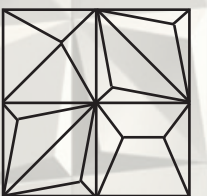



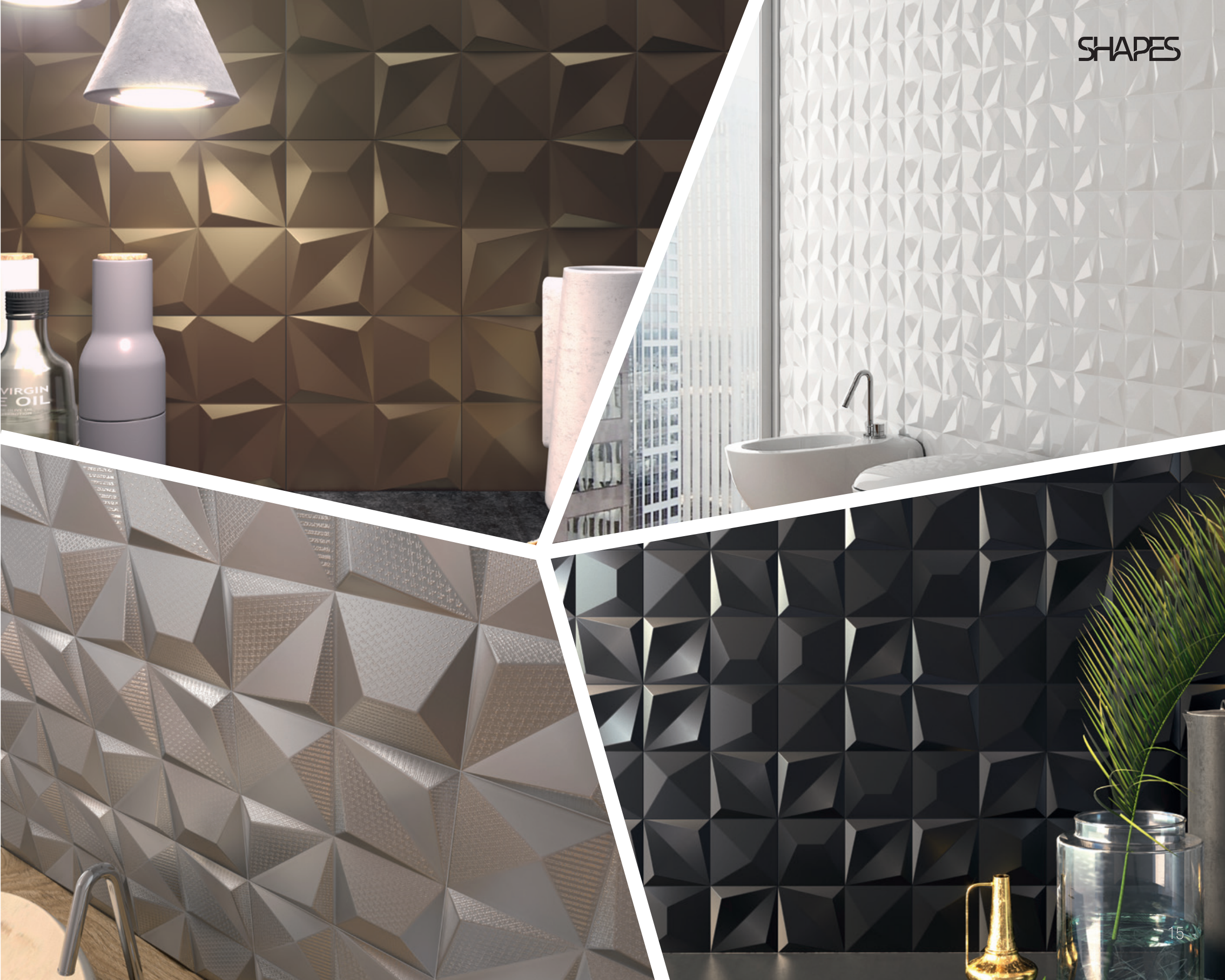



Con la mirada puesta en Asia nos inspiramos en la  
belleza de las formas orgánicas y curvas.  
Esta colección es una oda a la naturaleza.  
Las formas de los relieves, en apariencia simples,  
dan un sinfín de opciones de colocación.  
Consta de tres tonalidades mate: Blanco, Panna y  
Greige; una brillo: Luce; y una metalizada: Bronzo.

Al igual que la anterior esta colección propone dar rienda  
suelta a la creatividad, para así crear, a partir de la  
simplicidad, una composición compleja donde las luces y  
las sombras sean las protagonistas.

*With our eyes to Asia, we are inspired by the beauty of organic  
and curved forms. This collection is an ode to nature. The shapes  
of the reliefs, seemingly simple, offer an endless possibility of  
pattern layouts. This collection consists of three matt tones:  
White, Panna and Greige; a gloss tone: Luce; and  
a metallic one: Bronzo.*

*As with the previous one, this collection proposes to give  
free rein in creativity, in order to create, from the  
simplicity, a complex composition where lights and  
shades are the protagonists.*

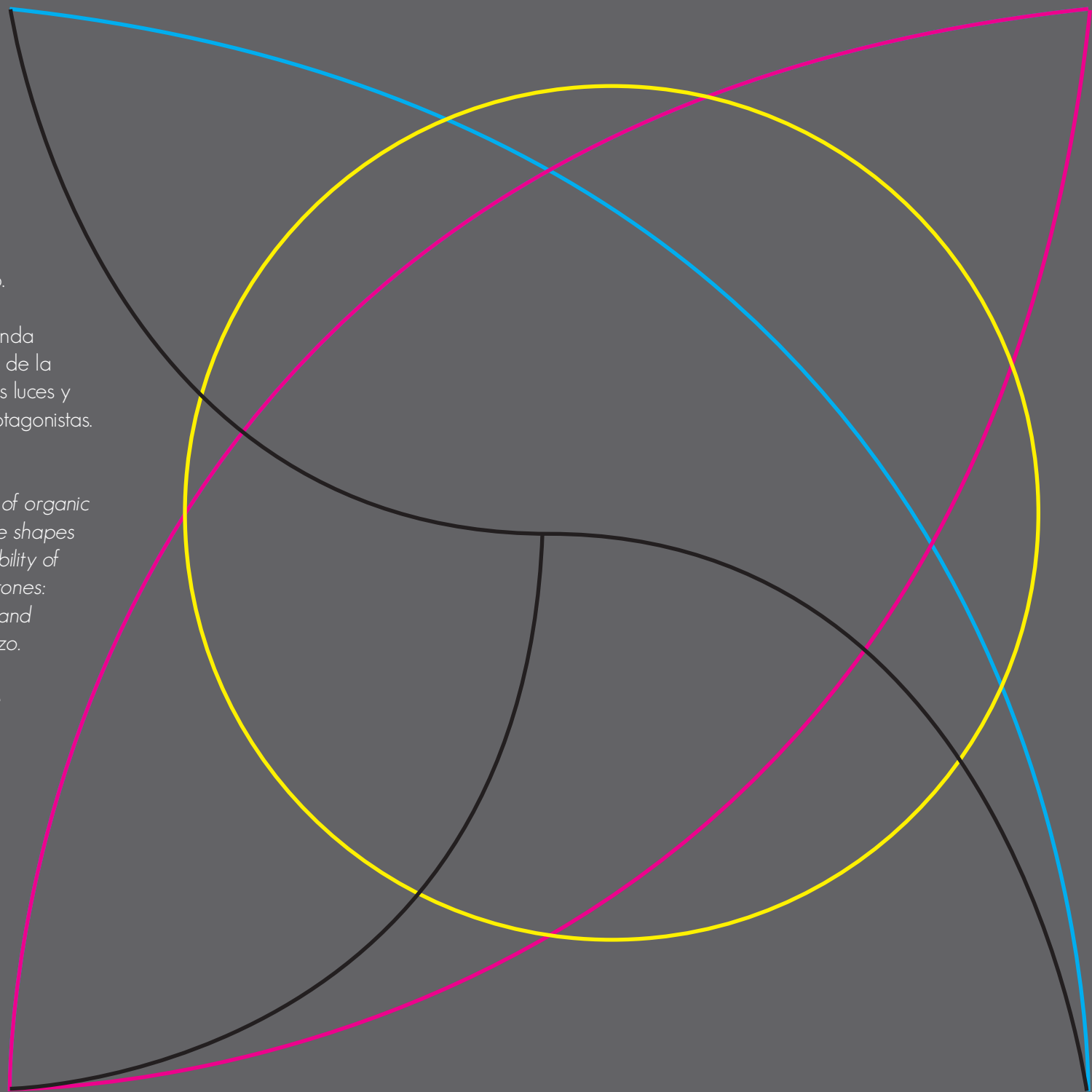

# #2

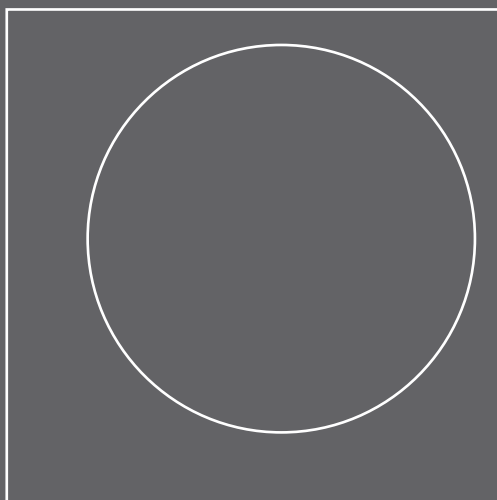

luna

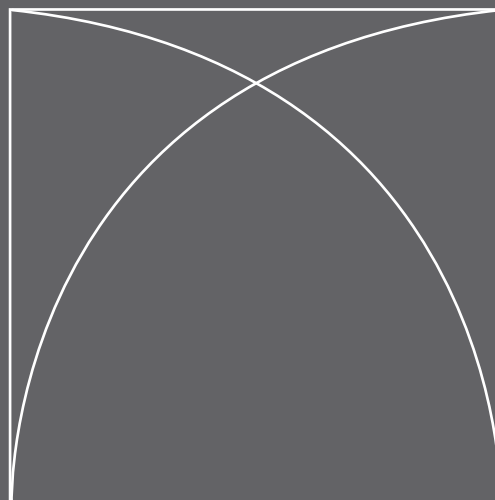

bivio

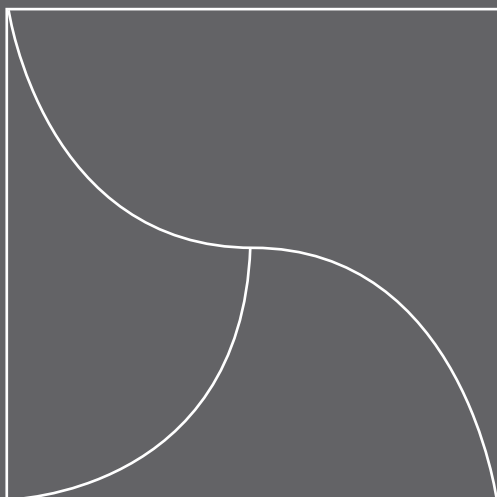

aria

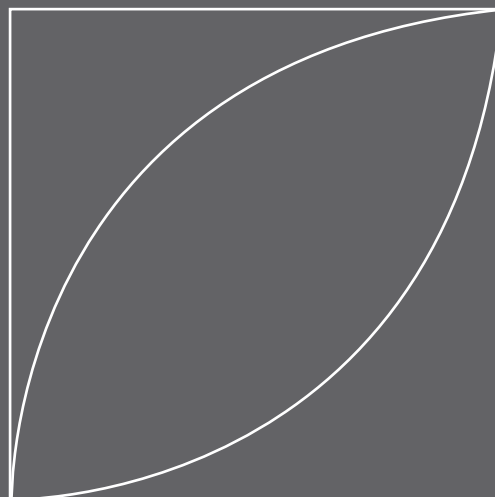

mandorla



white



luce



panna



greige



bronzo



# SHAPES #2

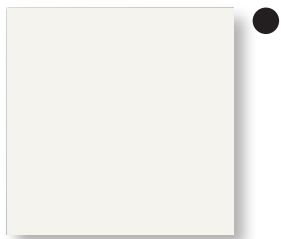

187328 Shapes White  
25x25 cm./9.8"x9.8" M914  
9 mm. de espesor/thickness

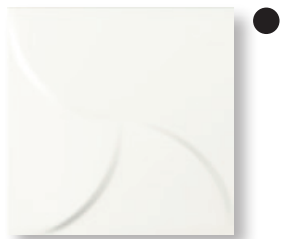

187415 Aria White  
25x25 cm./9.8"x9.8" M941  
9 mm. de espesor/thickness



187406 Bivio White  
25x25 cm./9.8"x9.8" M941  
9 mm. de espesor/thickness



187409 Luna White  
25x25 cm./9.8"x9.8" M941  
9 mm. de espesor/thickness



187412 Mandorla White  
25x25 cm./9.8"x9.8" M941  
9 mm. de espesor/thickness



187434 Shapes Luce  
25x25 cm./9.8"x9.8" M927  
9 mm. de espesor/thickness

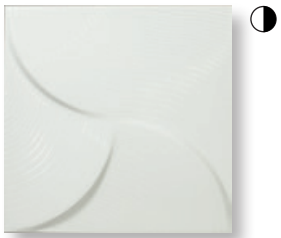

187432 Aria Luce  
25x25 cm./9.8"x9.8" M960  
9 mm. de espesor/thickness



187439 Bivio Luce  
25x25 cm./9.8"x9.8" M960  
9 mm. de espesor/thickness



187433 Luna Luce  
25x25 cm./9.8"x9.8" M960  
9 mm. de espesor/thickness



187431 Mandorla Luce  
25x25 cm./9.8"x9.8" M960  
9 mm. de espesor/thickness

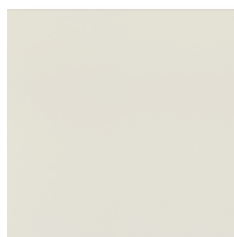

187405 Shapes Panna  
25x25 cm./9.8"x9.8" **M914**  
9 mm. de espesor/thickness

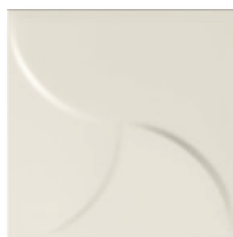

187417 Aria Panna  
25x25 cm./9.8"x9.8" **M941**  
9 mm. de espesor/thickness



187408 Bivio Panna  
25x25 cm./9.8"x9.8" **M941**  
9 mm. de espesor/thickness



187411 Luna Panna  
25x25 cm./9.8"x9.8" **M941**  
9 mm. de espesor/thickness



187414 Mandorla Panna  
25x25 cm./9.8"x9.8" **M941**  
9 mm. de espesor/thickness



187404 Shapes Greige  
25x25 cm./9.8"x9.8" **M914**  
9 mm. de espesor/thickness



187416 Aria Greige  
25x25 cm./9.8"x9.8" **M941**  
9 mm. de espesor/thickness



187407 Bivio Greige  
25x25 cm./9.8"x9.8" **M941**  
9 mm. de espesor/thickness



187410 Luna Greige  
25x25 cm./9.8"x9.8" **M941**  
9 mm. de espesor/thickness



187413 Mandorla Greige  
25x25 cm./9.8"x9.8" **M941**  
9 mm. de espesor/thickness



187424 Shapes Bronzo  
25x25 cm./9.8"x9.8" **M941**  
9 mm. de espesor/thickness



187421 Aria Bronzo  
25x25 cm./9.8"x9.8" **M963**  
9 mm. de espesor/thickness



187418 Bivio Bronzo  
25x25 cm./9.8"x9.8" **M963**  
9 mm. de espesor/thickness



187419 Luna Bronzo  
25x25 cm./9.8"x9.8" **M963**  
9 mm. de espesor/thickness



187420 Mandorla Bronzo  
25x25 cm./9.8"x9.8" **M963**  
9 mm. de espesor/thickness

● Acabado Mate/Matt Finish

◐ Acabado Satinado ó Mix Brillo-Mate / Satin Finish or Mix Glossy-Mat













Luna



Luna. Es un relieve inspirado en el único satélite natural que tiene la tierra, la luna. Su desplazamiento dentro del azulejo representa el movimiento de la misma en el cielo.  
*Luna. It is a relief inspired by the only natural satellite of the earth, the moon. Its displacement inside the tile represents the movement of it in the sky.*







Aria



Aria. El nombre de este relieve también proviene del italiano, y significa "Aire". Sus formas evocan a las aspas de los molinos de viento.  
Aria. The name of this relief also comes from the Italian language, and means "Air". Its shapes evoke the blades of the windmills.



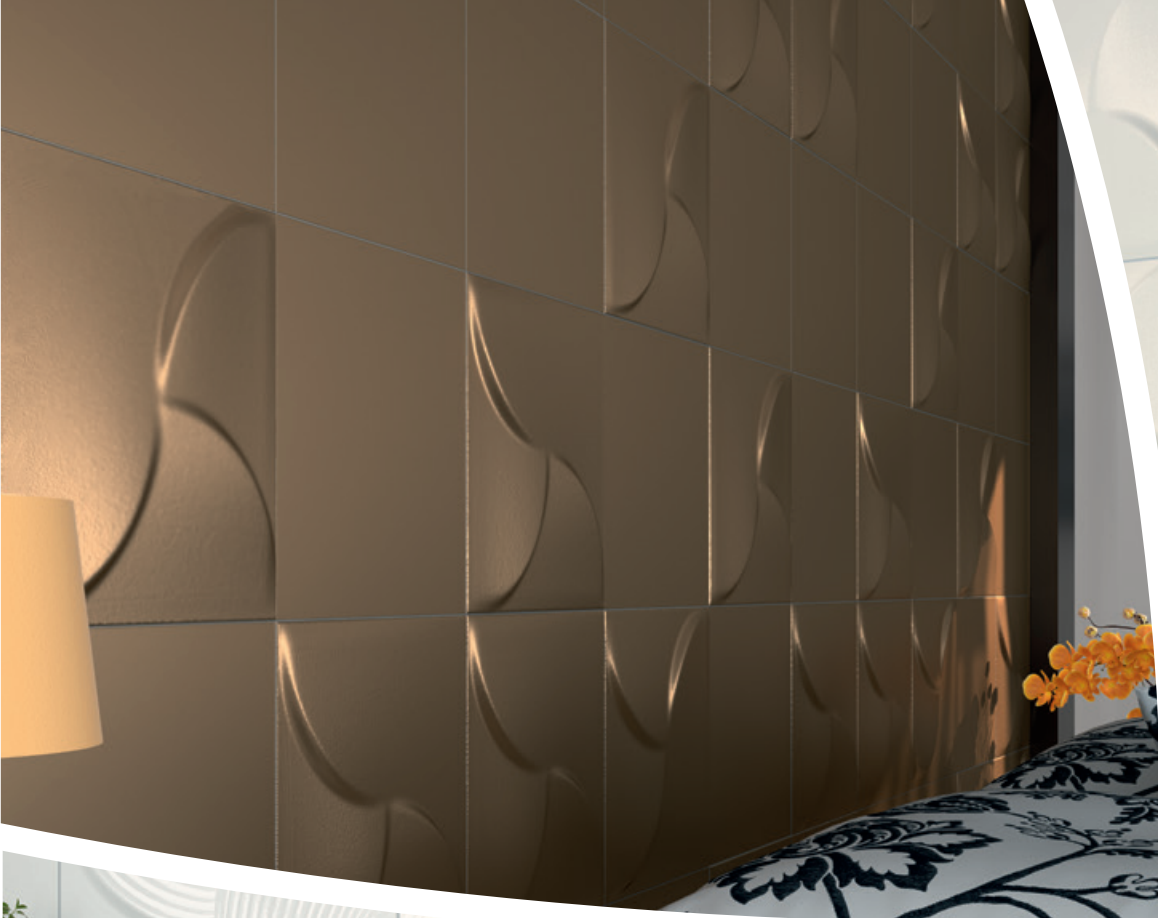





Mandorla. "Almendra" en italiano. Esta forma tiene un gran significado en el mundo del arte. Su forma proviene de dos círculos que se intersectan. Representa el camino entre los dos mundos, el terrenal y el celestial. También las hojas de los árboles.  
 Mandorla. "Almond" in Italian. This form has great significance in the art world. Its shape comes from two intersecting circles. It represents the way between the two worlds, the earthly and the celestial. Also the leaves of the trees.

Mandorla

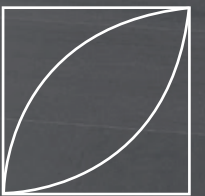









PROJECTS



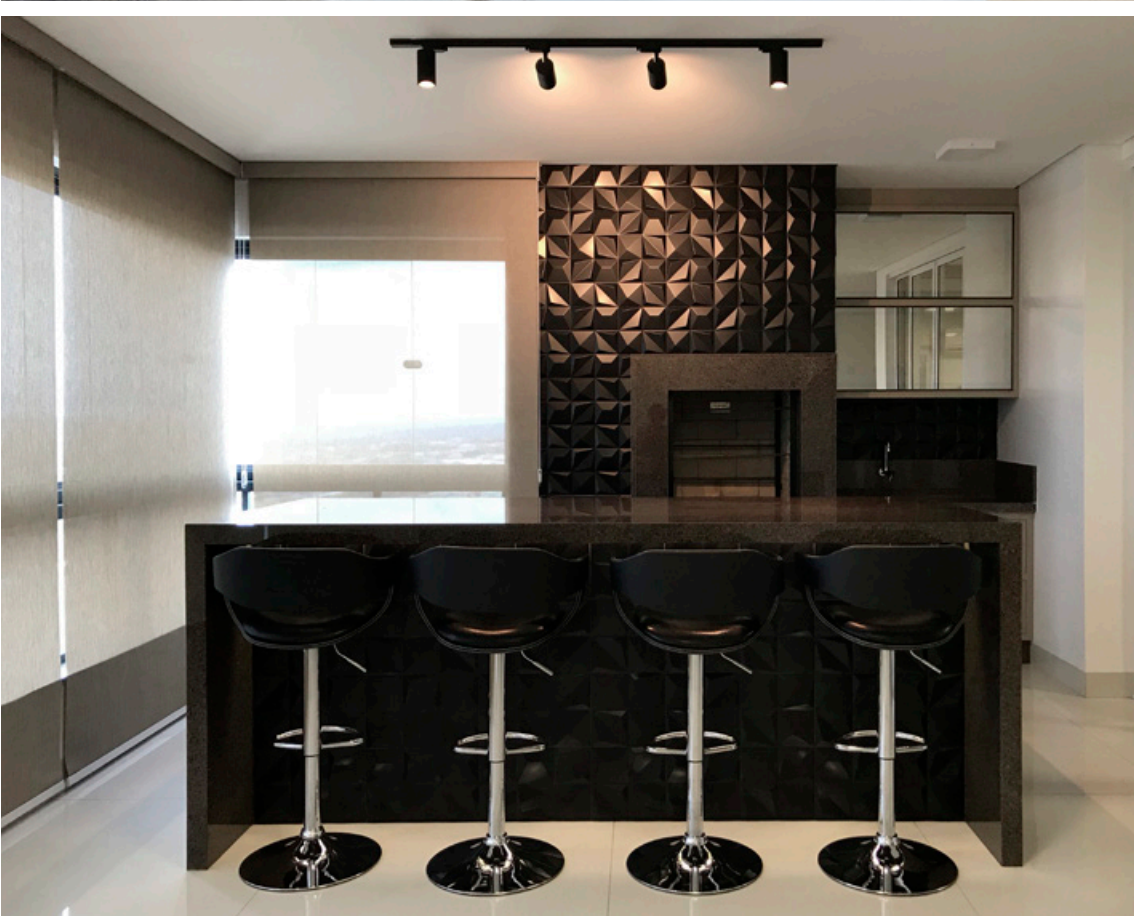

SHAPES



La sucesión continua de puntos da lugar a la línea, el grafismo más sencillo y puro, capaz de generar estructuras versátiles.

STRIPES es una nueva serie surcada por finas líneas que recoge el lado más minimal y, a la vez, más rico que se puede lograr con esta simplicidad: con un simple giro de las piezas, generamos patrones cambiantes donde la luz juega con nuestros sentidos y nos hace ver matices cromáticos en cada una de sus secciones.

La inspiración de sus acabados tiene como eje central la naturaleza: maderas, bambú, mármol o metales generan superficies sorprendentes. Sus versiones textiles, de lino o el denim, nos acercan la calidez de los tejidos naturales.

*In the simplest and purest graphic form rises a line versatile for many structures. STRIPES is a new series where fine lines cover the surface of the tiles, expressing the most minimal side of this pattern while achieving its richest aesthetic through simplicity. By the turn of each piece, we generate changing patterns where the light plays with our senses by showing nuances in its design.*

*The inspiration of its finishes comes from nature: wood, bamboo, marble or metals generate surprising compositions. The textile inspired denim and linen bring us closer to the warmth of natural fabrics.*

# #3

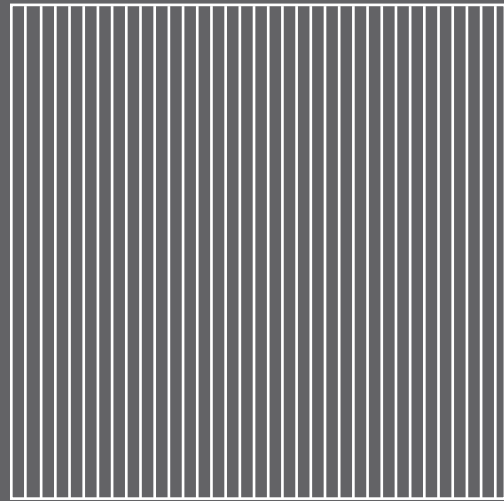

stripes



calacatta



bamboo



teak

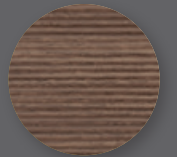

oak

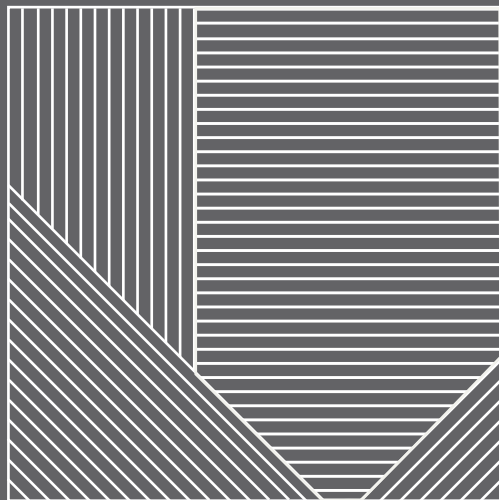

stripes mix



linen



denim



glacier

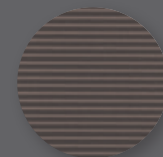

mercury



copper



# SHAPES #3

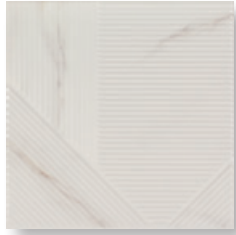

187599 Stripes Mix Calacatta  
25x25 cm./9.8"x9.8" M960  
10 mm. de espesor/thickness

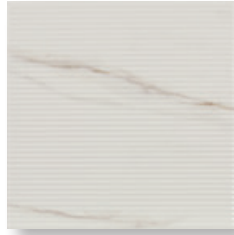

187596 Stripes Calacatta  
25x25 cm./9.8"x9.8" M960  
10 mm. de espesor/thickness



187562 Stripes Mix Linen  
25x25 cm./9.8"x9.8" M960  
10 mm. de espesor/thickness

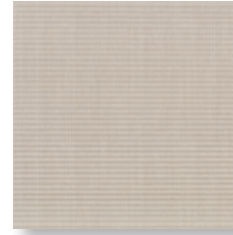

187560 Stripes Linen  
25x25 cm./9.8"x9.8" M960  
10 mm. de espesor/thickness



187563 Stripes Mix Denim  
25x25 cm./9.8"x9.8" M960  
10 mm. de espesor/thickness



187561 Stripes Denim  
25x25 cm./9.8"x9.8" M960  
10 mm. de espesor/thickness



187546 Stripes Mix Teak  
25x25 cm./9.8"x9.8" M960  
10 mm. de espesor/thickness



187543 Stripes Teak  
25x25 cm./9.8"x9.8" M960  
10 mm. de espesor/thickness



187547 Stripes Mix Bamboo  
25x25 cm./9.8"x9.8" M960  
10 mm. de espesor/thickness



187544 Stripes Bamboo  
25x25 cm./9.8"x9.8" M960  
10 mm. de espesor/thickness



187548 Stripes Mix Oak  
25x25 cm./9.8"x9.8" M960  
10 mm. de espesor/thickness



187545 Stripes Oak  
25x25 cm./9.8"x9.8" M960  
10 mm. de espesor/thickness



187558 Stripes Mix Glacier  
25x25 cm./9.8"x9.8" M963  
10 mm. de espesor/thickness



187564 Stripes Glacier  
25x25 cm./9.8"x9.8" M963  
10 mm. de espesor/thickness



187559 Stripes Mix Mercury  
25x25 cm./9.8"x9.8" M963  
10 mm. de espesor/thickness



187565 Stripes Mercury  
25x25 cm./9.8"x9.8" M963  
10 mm. de espesor/thickness



187557 Stripes Mix Copper  
25x25 cm./9.8"x9.8" M963  
10 mm. de espesor/thickness

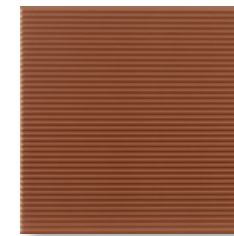

187566 Stripes Copper  
25x25 cm./9.8"x9.8" M963  
10 mm. de espesor/thickness

- Novedad / New
- Acabado Brillo/Glossy Finish
- Acabado Mate/Matt Finish
- Acabado Satinado ó Mix Brillo-Mate / Satin Finish or Mix Glossy-Mat
- Producto natural sujeto a destonificaciones / Natural product that might suffer colour variations





Un diseño único de mármol calacatta cubre superficies brillo y mate, generando sutiles cambios de luz.  
A unique design of calacatta marble covers glossy and matt areas, creating subtle changes of light and shadows.













La naturalidad del lino o el carácter juvenil del denim, dos diseños textiles para ambientes cálidos y acogedores, tanto en su versión lisa como en patchwork. The natural feel of linen and the youthful character of denim create two dynamic textile designs that add warmth while creating welcoming environments. Create endless combinations and patterns with plain or mixed patchwork designs.









Glacier, una propuesta en blanco metalizado para espacios delicados y elegantes, que evoca a los destellos de luz sobre paisajes polares. La propuesta metálica de Stripes se completa con Mercury y Copper.

*Glacier, a white reflective finish for delicate and elegant spaces, evokes the flashes of light on polar landscapes. Stripes' metallic designs also encompass the beauty of Mercury and Copper.*







TRANSVERSE es la serie más técnica de SHAPES, realizada en pequeño formato y porcelánico técnico, diseñada para construir espacios interiores y exteriores. Su belleza radica en la simplicidad de su diseño, con cuatro formas geométricas de grosor variable, que invitan a crear composiciones diversas, jugando con la posición de las piezas.

Colores neutros, líneas diagonales y lados que suben y bajan, así es TRANSVERSE inspirada en el minimalismo de la cerámica japonesa, donde la luz se recrea en los relieves, generando sutiles juegos de luces y sombras.

Clay, cement y graphite constituyen la gama cromática de Transverse, donde imperan el orden y la repetición, sólo alterables con toques de decoración que aportan cuatro propuestas basadas en la madera, los metales y los esmaltes de la cerámica artesanal.

*TRANSVERSE, the most technical series of SHAPES, is a small format, full body porcelain designed for interior and exterior spaces. Its beauty lies in the simplicity of the design of four geometric shapes in irregular thickness which invite you to create diverse compositions.*

*Inspired by the minimalism of Japanese design, TRANSVERSE uses neutral colors with simple diagonal lines and varying thickness to interact with light. These reliefs generate subtle contrasts made by the shadows for a stunning design.*

*Clay, cement, and graphite make the palette of TRANSVERSE, where order and repetition prevail in its purest form. Dress up the design with matching decorative pieces inspired by wood, metals and handmade ceramics.*



# #4

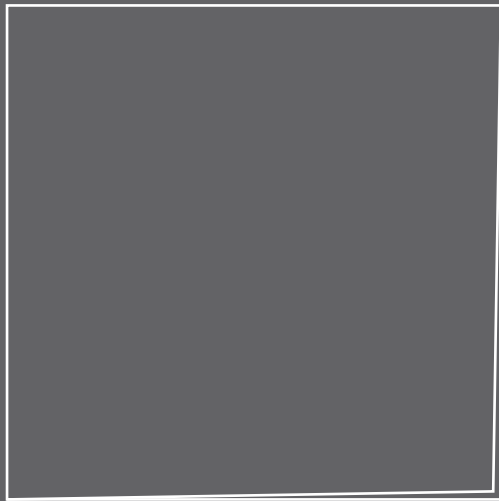

Transverse 1

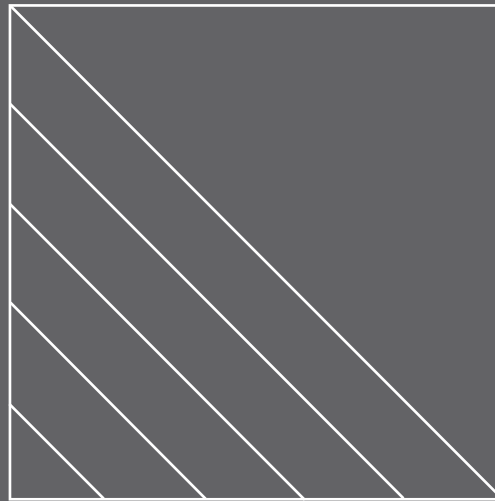

Transverse 2

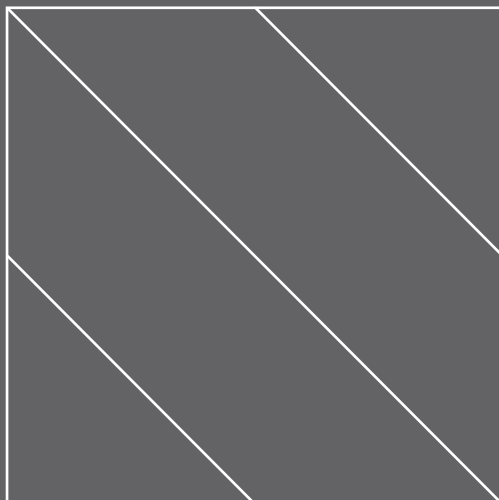

Transverse 4

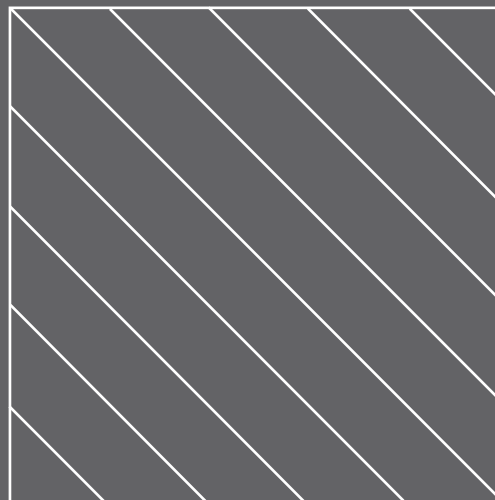

Transverse 3



clay



cement

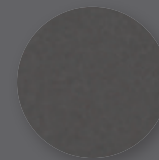

graphite

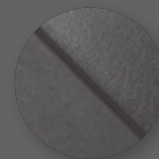

luce



wood



crackle



copper

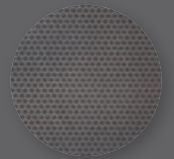

metal



# SHAPES #4





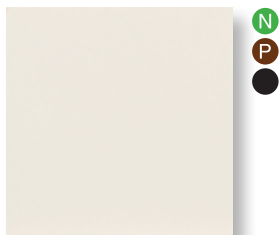

187574 Transverse 1 Clay  
14,7x14,7 cm./5.8"x5.8" **M963**  
14 mm. de espesor/thickness



187578 Transverse 2 Clay  
14,7x14,7 cm./5.8"x5.8" **M963**  
13 mm. de espesor/thickness

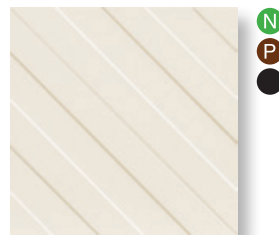

187571 Transverse 3 Clay  
14,7x14,7 cm./5.8"x5.8" **M963**  
11 mm. de espesor/thickness

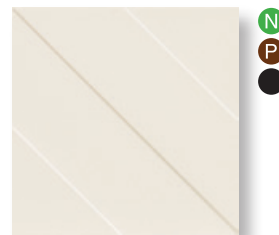

187580 Transverse 4 Clay  
14,7x14,7 cm./5.8"x5.8" **M963**  
10 mm. de espesor/thickness

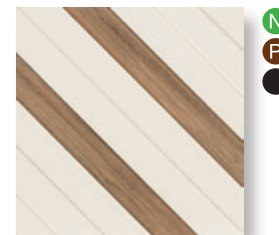

187617 Transverse 3 Wood  
14,7x14,7 cm./5.8"x5.8" **D55**  
11 mm. de espesor/thickness



187618 Transverse 2 Crackle  
14,7x14,7 cm./5.8"x5.8" **D55**  
13 mm. de espesor/thickness

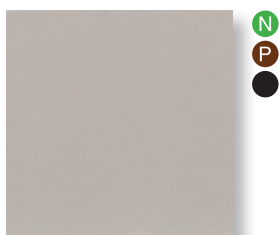

187575 Transverse 1 Cement  
14,7x14,7 cm./5.8"x5.8" **M963**  
14 mm. de espesor/thickness

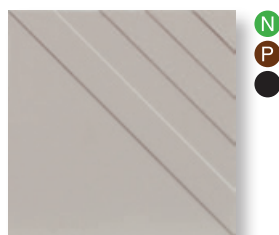

187579 Transverse 2 Cement  
14,7x14,7 cm./5.8"x5.8" **M963**  
13 mm. de espesor/thickness

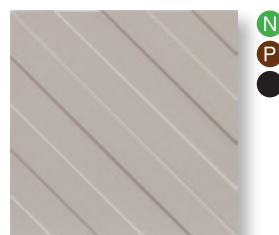

187572 Transverse 3 Cement  
14,7x14,7 cm./5.8"x5.8" **M963**  
11 mm. de espesor/thickness

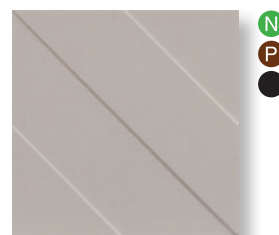

187581 Transverse 4 Cement  
14,7x14,7 cm./5.8"x5.8" **M963**  
10 mm. de espesor/thickness



187610 Transverse 4 Copper  
14,7x14,7 cm./5.8"x5.8" **D280**  
10 mm. de espesor/thickness

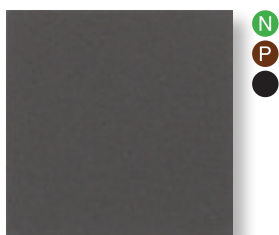

187576 Transverse 1 Graphite  
14,7x14,7 cm./5.8"x5.8" **M963**  
14 mm. de espesor/thickness

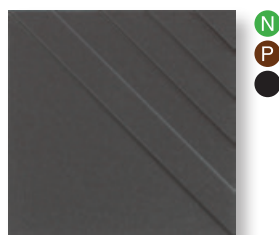

187577 Transverse 2 Graphite  
14,7x14,7 cm./5.8"x5.8" **M963**  
13 mm. de espesor/thickness

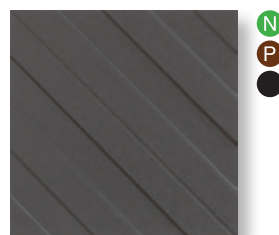

187573 Transverse 3 Graphite  
14,7x14,7 cm./5.8"x5.8" **M963**  
11 mm. de espesor/thickness

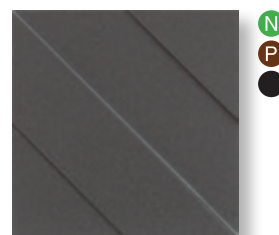

187582 Transverse 4 Graphite  
14,7x14,7 cm./5.8"x5.8" **M963**  
10 mm. de espesor/thickness

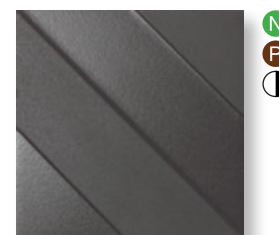

187628 Transverse 4 Luce  
14,7x14,7 cm./5.8"x5.8" **M976**  
10 mm. de espesor/thickness



187627 Transverse 1 Metal  
14,7x14,7 cm./5.8"x5.8" **D55**  
14 mm. de espesor/thickness



- Novedad / *New*
- Porcelánico / *Porcelain*
- Producto delicado / *Delicate product*
- Aplicación metálica PVD / *Metalic application PVD*
- Acabado Brillo/*Glossy Finish*
- Acabado Mate/*Matt Finish*
- Acabado Satinado ó Mix Brillo-Mate / *Satin Finish or Mix Glossy-Mat*

**D:** Venta a pieza / *Sold per piece.*

**M:** Venta en m<sup>2</sup> y a cajas completas/ *Sold per sqm in complete boxes.*





## Transverse 1

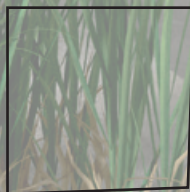

Una suave pendiente es la esencia de este relieve realizado con porcelánico técnico. Su aparente simplicidad esconde una invitación a crear patrones distintos, levantando y hundiendo las esquinas, a través del giro de las piezas.

*A smooth slope is the essence of this full body porcelain relief. Behind its apparent simplicity hides an invitation to create different patterns with just a turn of the tile due to the varying thickness of its corners.*









Transverse 2

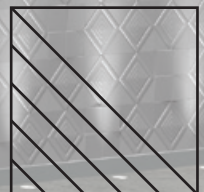

Dos planos simétricos, uno liso y otro surcado por diagonales, descienden desde los extremos hasta converger en el centro de la pieza, dejando a la vista ángulos y bordes que se integran en el diseño, enriqueciendo el conjunto.  
 Two symmetrical planes descend from extremes to converge in the center of each piece where one plane is flat while the other is crossed by diagonals. The result is the angles and edges that play a key role in the design of this series.









MON  
LOUNGE

Airbnb

Relieve con espesor regular y líneas diagonales paralelas, para crear patrones abiertos o cerrados de espigas, rombos y líneas, siempre con gran equilibrio.  
*Uniformed in thickness, this relief with parallel diagonal lines create open or closed patterns of chevrons, diamonds or lines. These classic designs are always pure and balanced.*

Transverse 3

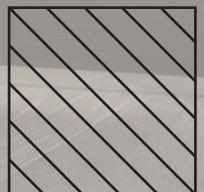









Azulejo de espesor regular y depurado diseño, con amplias franjas que recorren la pieza en diagonal para crear formas en zig-zag, rombo, líneas o patrones abiertos de gran belleza.

*Wide stripes diagonally intersect the surface to create simple but sophisticated patterns. Create chevrons, diamonds, rhombus or linear designs for classic and grand beauty.*

Transverse 4









# #1

## Shapes

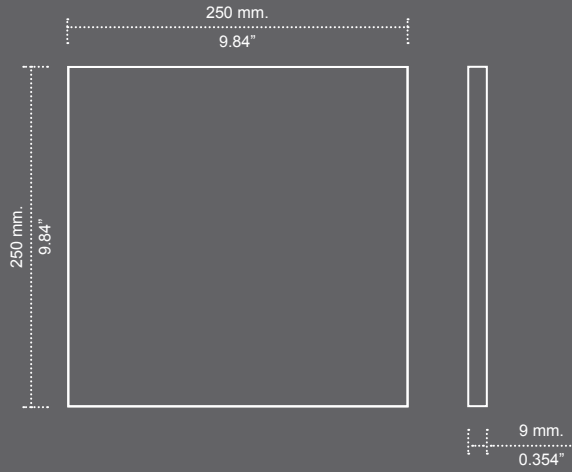

## Japan

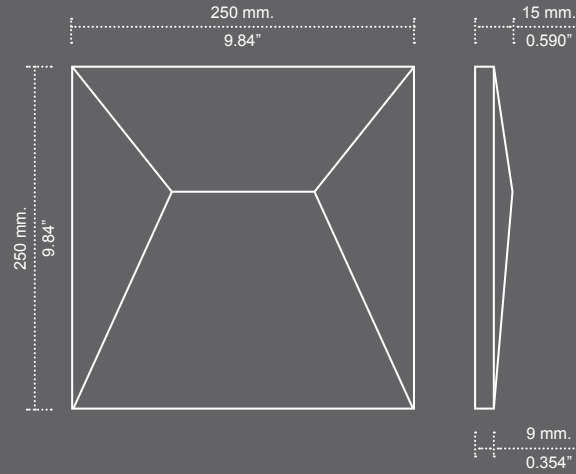

## Origami

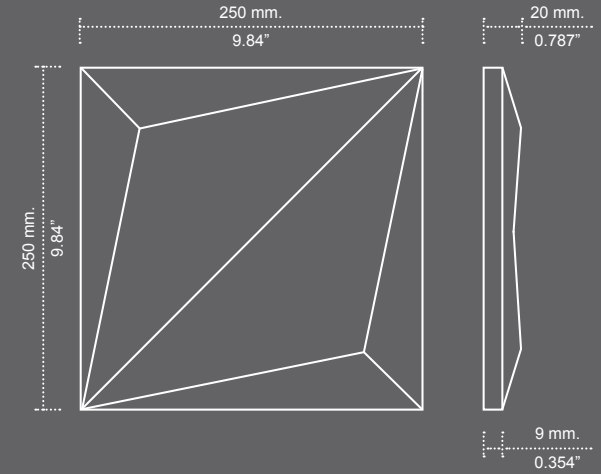

## Kioto

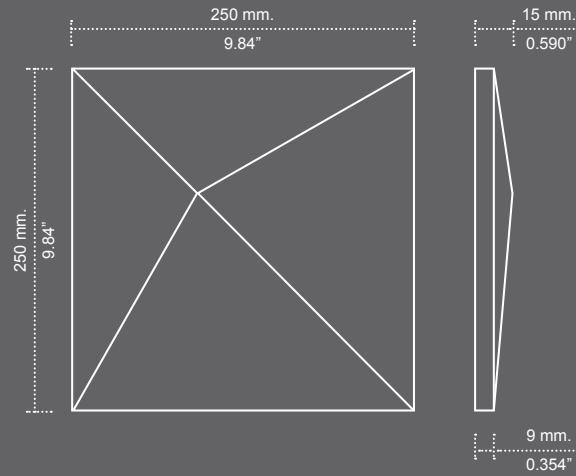

## Multishapes

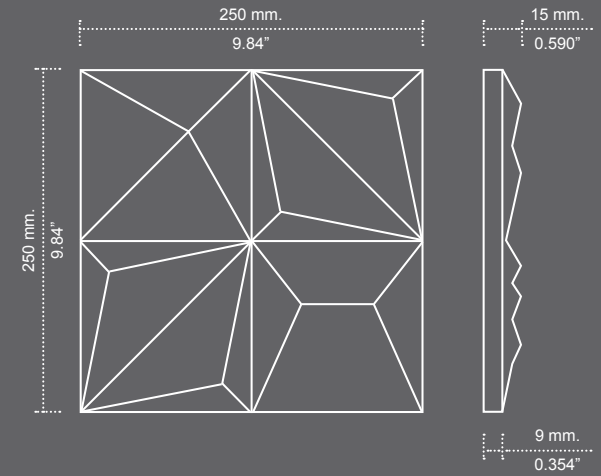



# #2

Luna

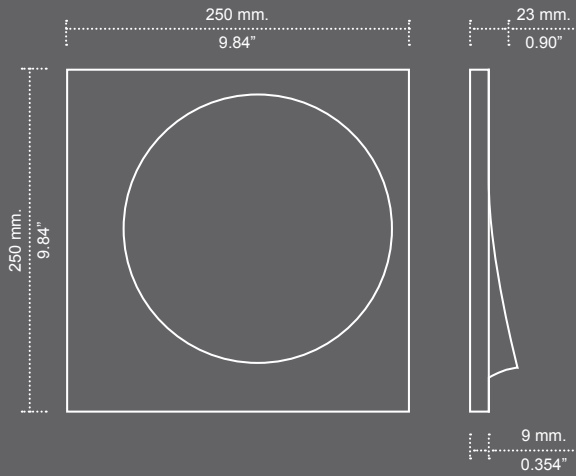

Bivio

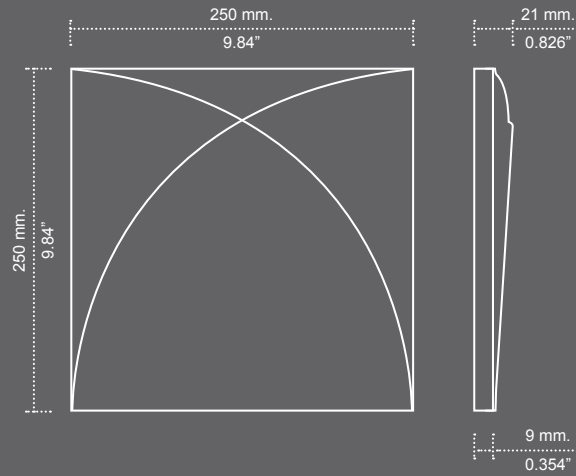

Shapes

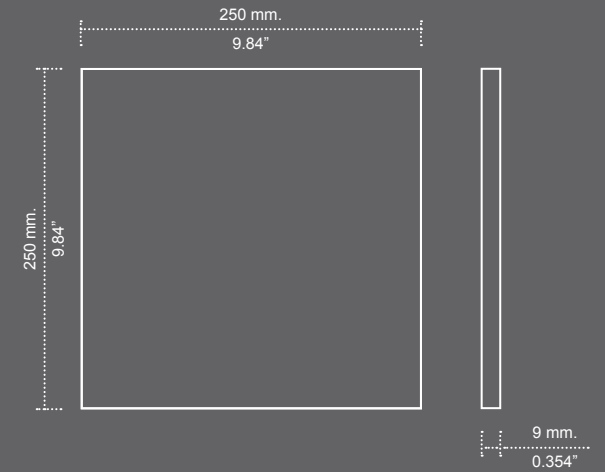

Aria

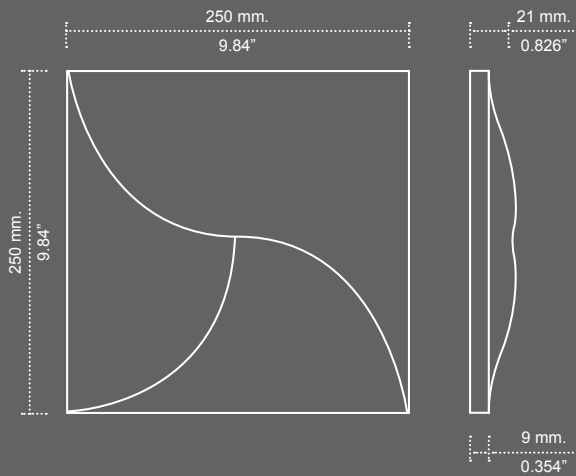

Mandorla

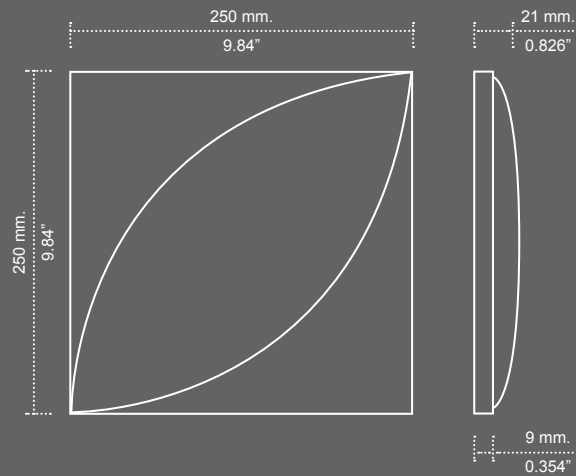



# #3

Stripes

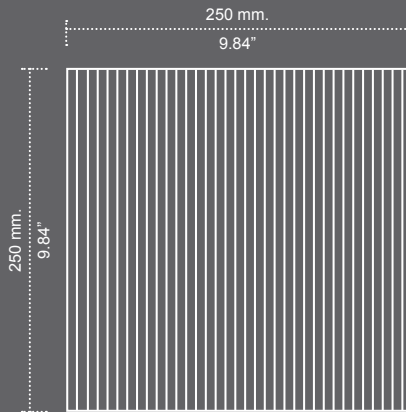

Stripes Mix

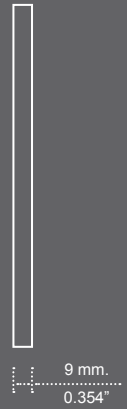
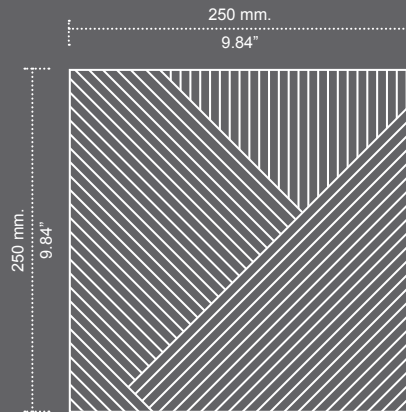
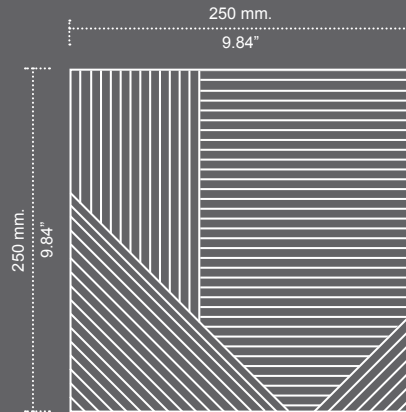



# #4

Transverse 1

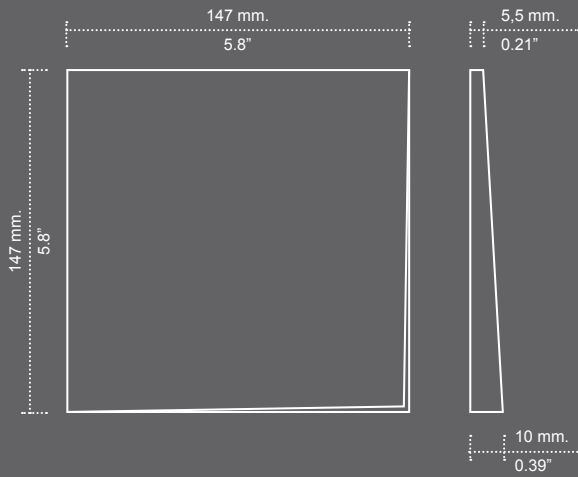

Transverse 2

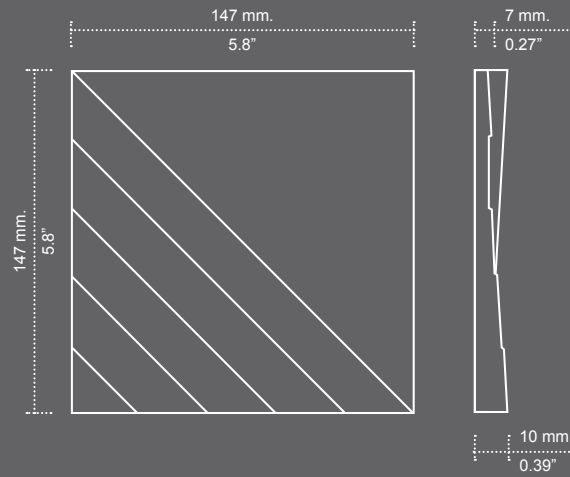

Transverse 3

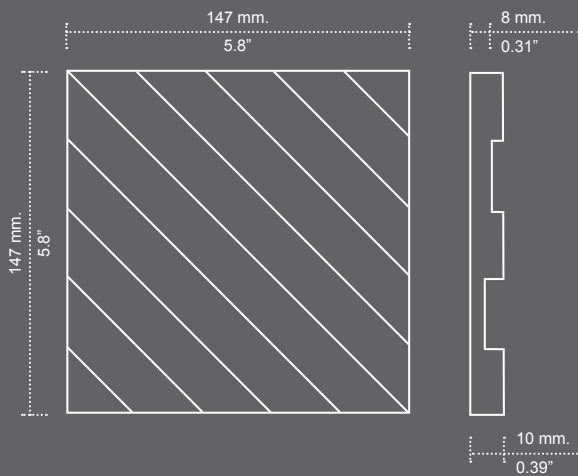

Transverse 4

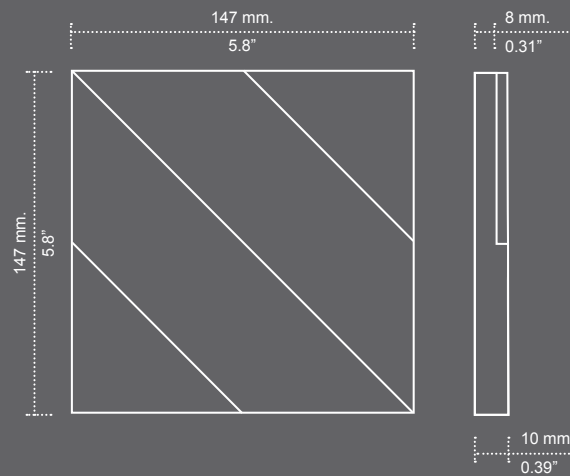

Gres Porcelánico Técnico  
Full Body Porcelain Tile

Absorción de agua  
Water absorption

💧 < 0.5% Group BIa



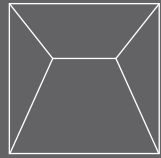

Japan

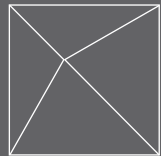
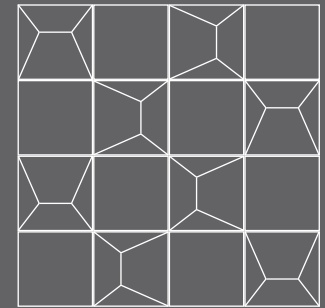
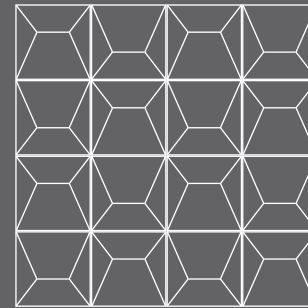
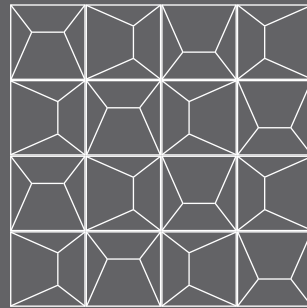
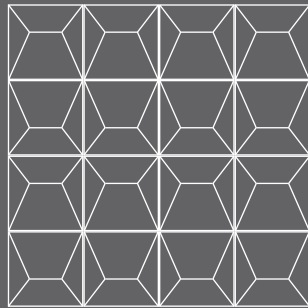

Kioto

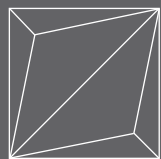
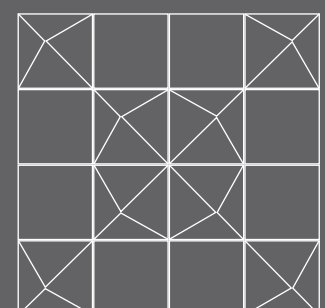
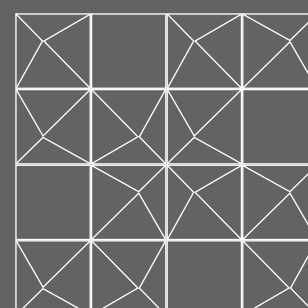
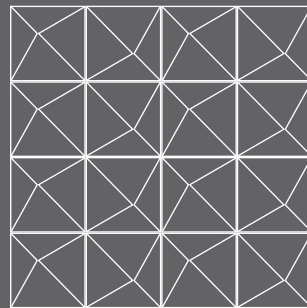
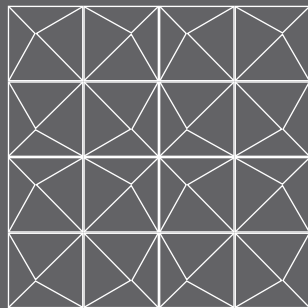

Origami

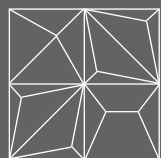
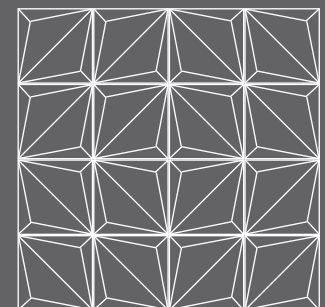
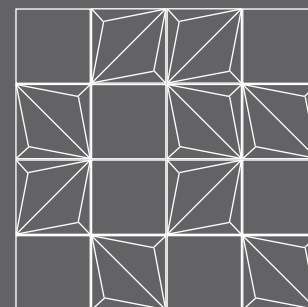
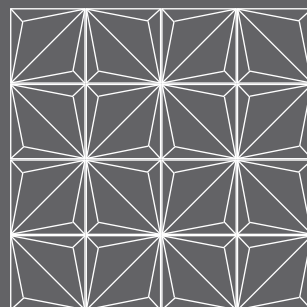
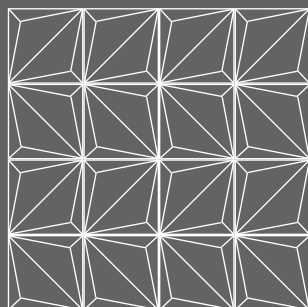

Multishapes

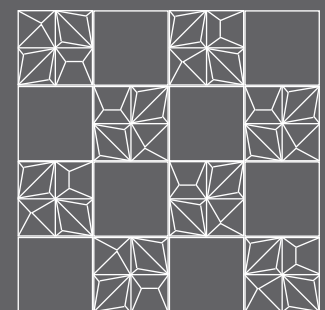
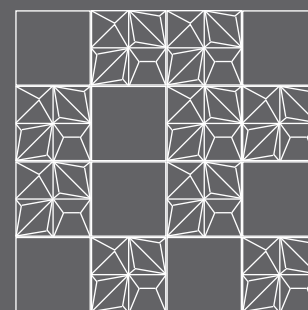
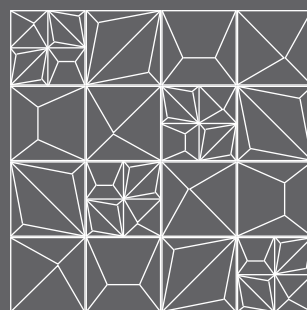
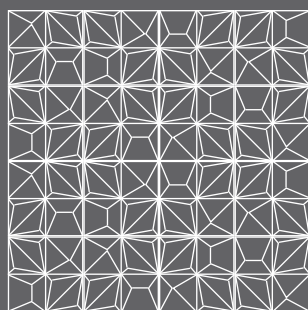



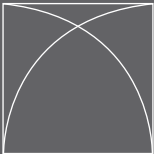

Bivio

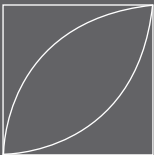
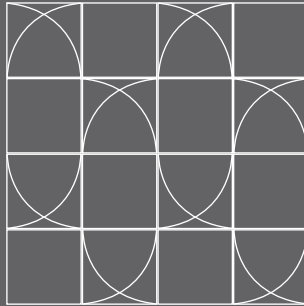
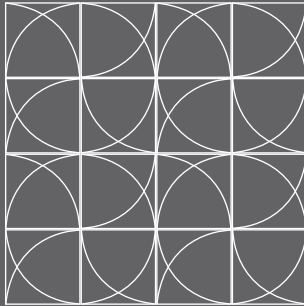
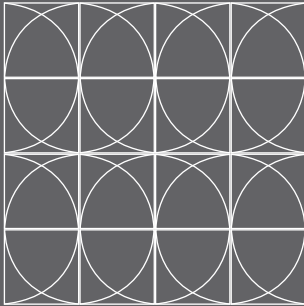
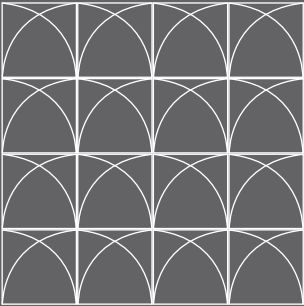

Mandorla

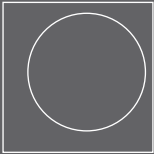
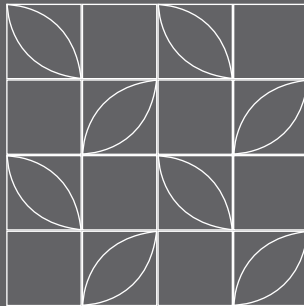
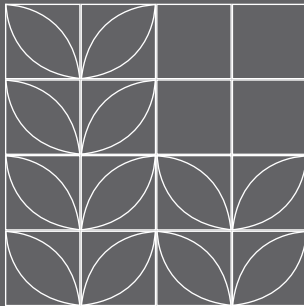
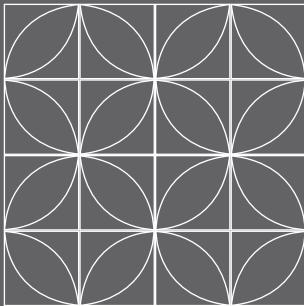
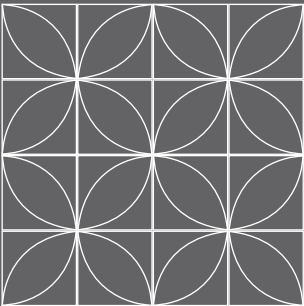

Luna

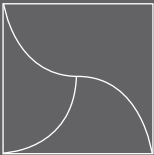
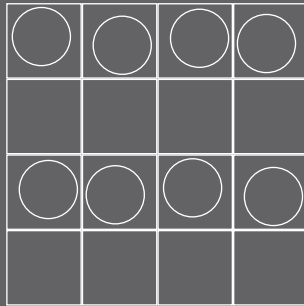
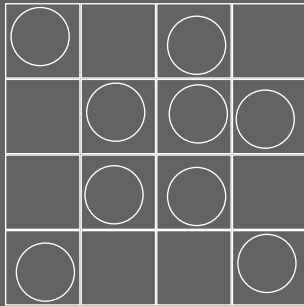
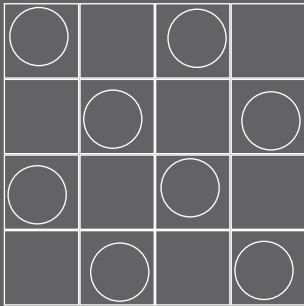
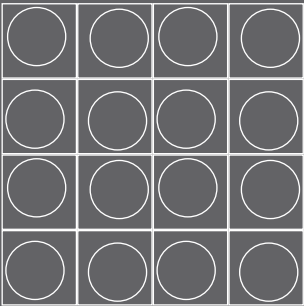

Aria

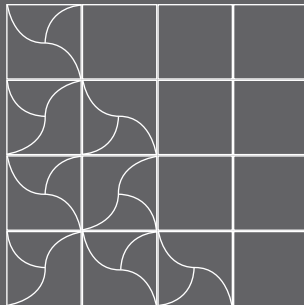
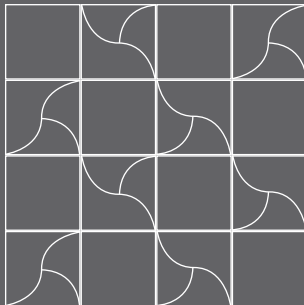
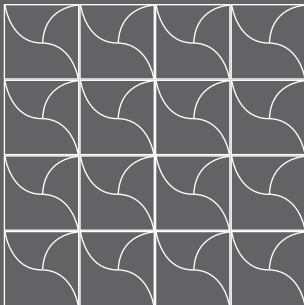
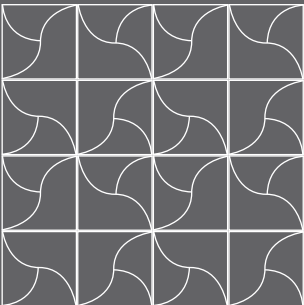



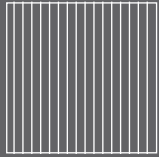

Stripes

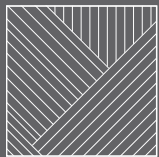
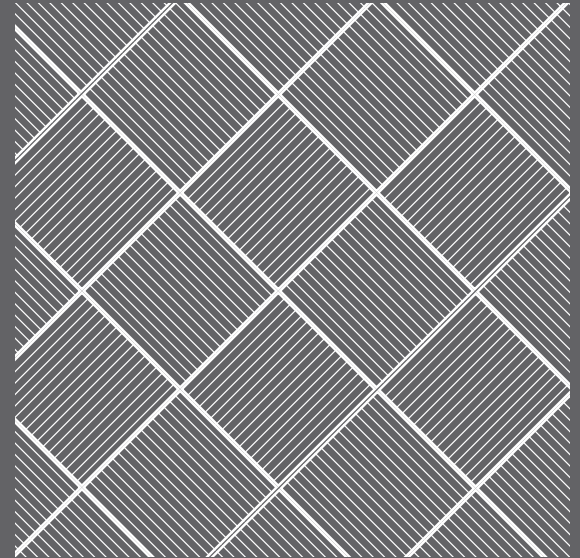
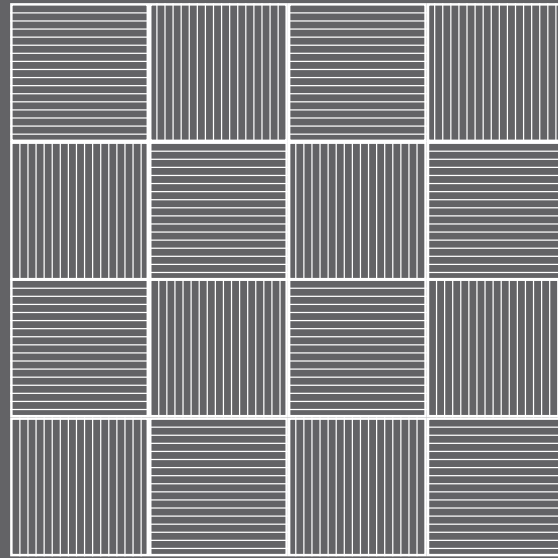
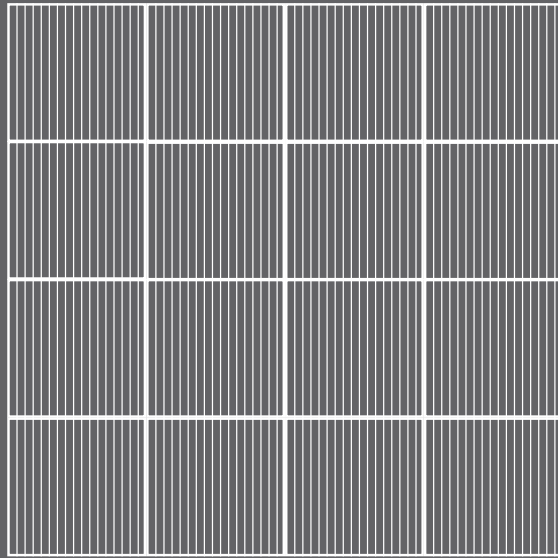

Stripes Mix

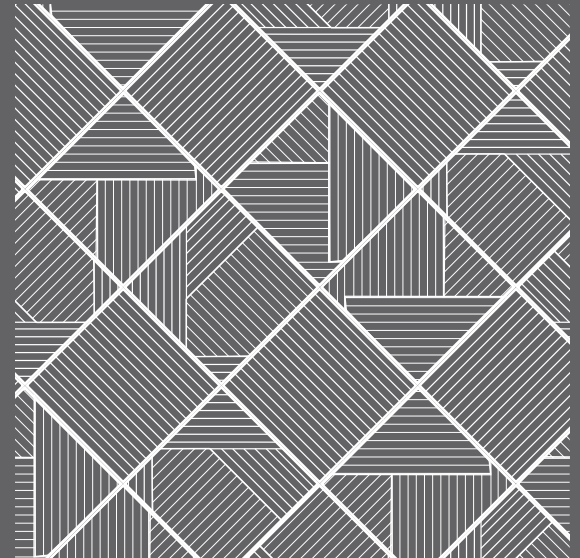
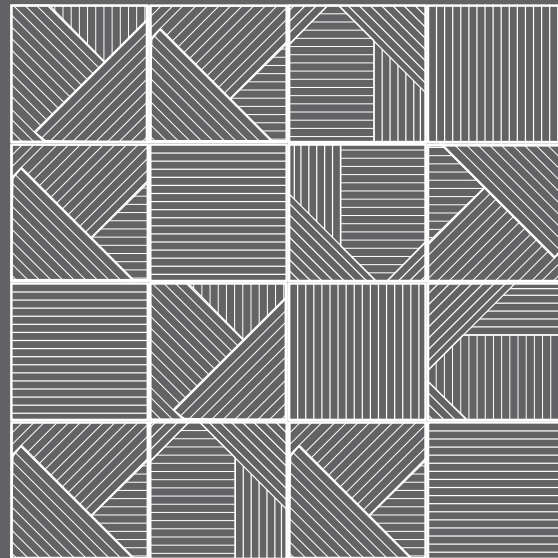
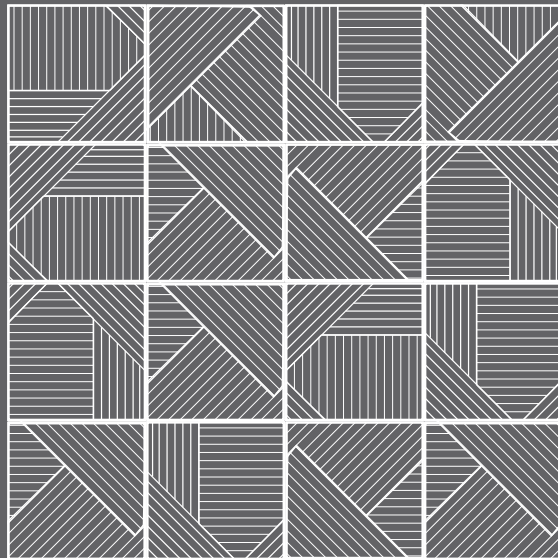



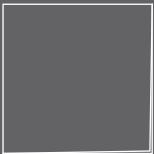

Transverse 1

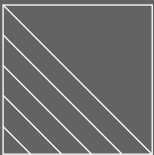
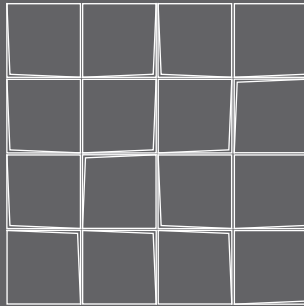
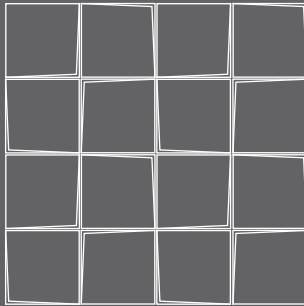
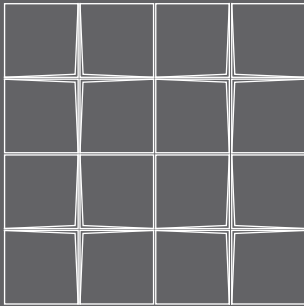
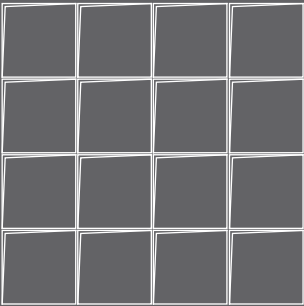

Transverse 2

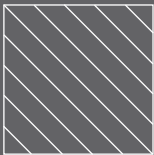
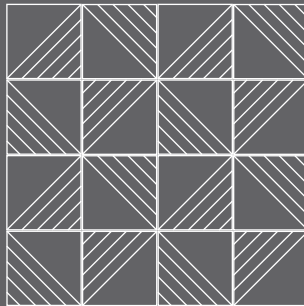
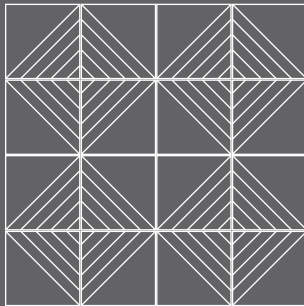
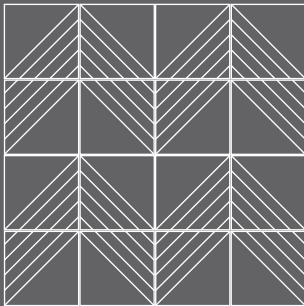
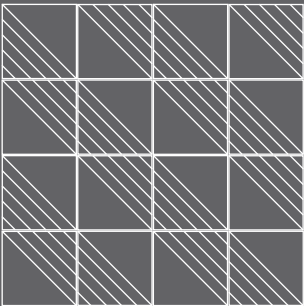

Transverse 3

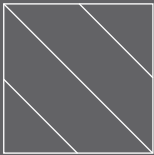
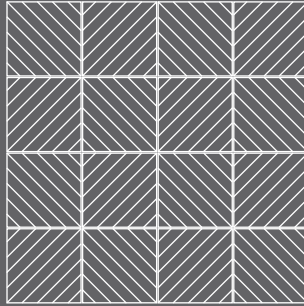
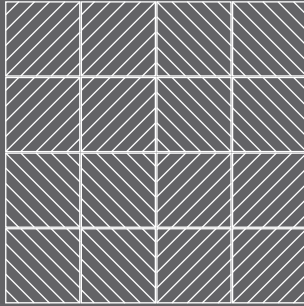
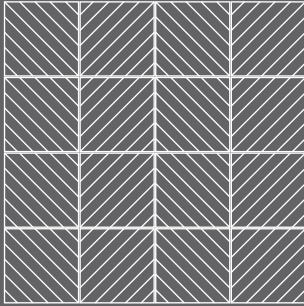
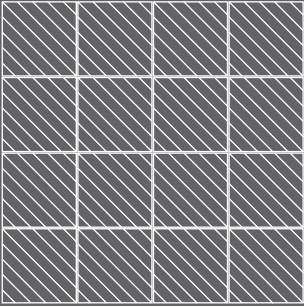

Transverse 4

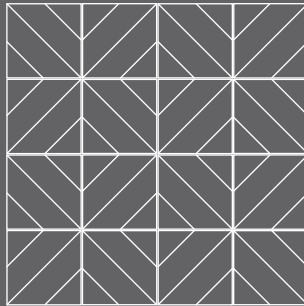
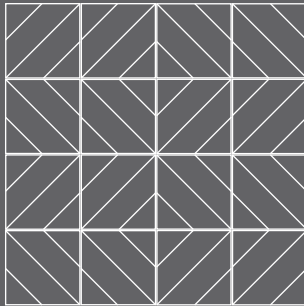
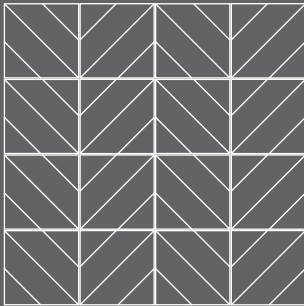
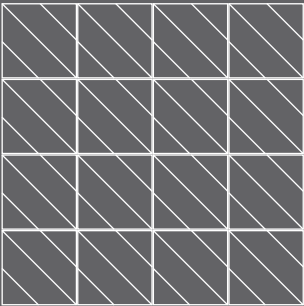



Interior  
Indoors  
Внутри  
Intérieur  
Interno  
Interior  
Innenbereiche  
室内  
يلخاد  
Wewnatrz



Pavimento bajo tránsito zonas húmedas  
Floors Light traffic in wet areas  
Напольная плитка низкая проходимость влажные з  
Sol trafic faible zones humides  
Pavimento basso traffico per zone umide  
Pavimento a pouco tráfego zonas húmidas  
Gering belastete Böden im Naßbereich  
适用于潮湿区域的低强度通行地砖  
ةبطرو وروم لة لي ل ق قطنم ي ف طالاب  
Płytki Podlogowe Do Strefy Mokrej



Pared ducha  
Shower Wall  
Стена душа  
Paroi de douche  
Parete doccia  
Parede de duche  
Naßbereich Wand  
浴室墙面  
شادلا رادج  
Sciana Prysznica



Exterior  
Outdoors  
Снаружи  
Extérieur  
Esterno  
Exterior  
Außenbereiche  
室外  
يخراغ  
Zewnatrz



Pavimento alto tránsito  
Floors - High traffic  
Напольная плитка высокая проходимость  
Sol trafic élevé  
Pavimento alto traffico  
Pavimento muito tráfego  
Stark belastete Böden  
高强度通行地砖  
لوادتم وروم وذا طالاب  
Płytki Podlogowe Przy Dużym Tranzycie



Piscina  
Swimming pool  
Бассейн  
Piscine  
Piscina  
Piscina  
Schwimmbad /unter Wasserbereiche  
游泳池  
ةحابسلا امامج  
Basen



Revestimiento  
Wall  
Настенная плитка  
Mural  
Rivestimento  
Revestimento  
Wand  
墙砖  
رادجلا  
Płytki Scienne



Pavimento radiante  
Underfloor Heating installation  
Полы с подогревом  
Sol chauffage au sol  
Pavimento per riscaldamento radiante  
Pavimento radiante  
Fußbodenheizung  
地板采暖  
طالابلا تحت ئفدت بي كرت  
Płytki Do Ogrzewania Podlogowego



Alta concentración de vapor (sauna, baño turco, etc)  
High vapor condensation areas (sauna, Turkish bath...)  
Высокая концентрация пара (сауна, турецкая баня и т.  
Forte concentration de vapeur (sauna, bain turc, etc...)  
Elevata concentrazione di vapore  
Alta concentração de vapor (sauna, banho turco, etc)  
Wellnessbereiche (Sauna, Türkisches Bad, etc.)  
高压蒸汽冷凝区域 (桑拿浴, 土耳其浴)  
...اي كرت امامجو انواس) رادج في كتلا ة لي ل ق قطنم ي ف طالاب  
Wysoka wilgotnosc (sauna, laznia turecka)





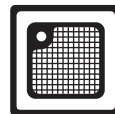



















Pavimento bajo tránsito zonas secas  
Floors Light traffic in dry areas  
Напольная плитка низкая проходимость сухие зоны  
Sol trafic faible zones sèches  
Pavimento basso traffico per zone non umide  
Pavimento pouco tráfego zonas secas  
Gering belastete Böden  
适用于干燥区域的低强度通行地砖  
ةفاج و وروم لة لي ل ق قطنم ي ف طالاب  
Płytki Podlogowe Do Strefy Suchej



Plato ducha  
Shower floor  
Душевой поддон  
Receveur de douche  
Piatto doccia  
Base de duche  
Naßbereich Boden  
浴室地面  
شادلا ةيخرا  
Podloga Prysznica



											
Aria Bronzo	•		•						•		•
Aria Greige	•		•						•		•
Aria Luce	•		•						•		•
Aria Panna	•		•						•		•
Aria White	•		•						•		•
Bivio Bronzo	•		•						•		•
Bivio Greige	•		•						•		•
Bivio Luce	•		•						•		•
Bivio Panna	•		•						•		•
Bivio White	•		•						•		•
Japan Black	•		•						•		•
Japan Bronzo	•		•						•		•
Japan Gold	•		•								
Japan Smoke	•		•						•		•
Japan White	•		•						•		•
Japan White Gloss	•		•						•		•
Kioto Black	•		•						•		•
Kioto Bronzo	•		•						•		•
Kioto Silver	•		•								
Kioto Smoke	•		•						•		•
Kioto White	•		•						•		•
Kioto White Gloss	•		•						•		•
Luna Bronzo	•		•						•		•
Luna Greige	•		•						•		•
Luna Luce	•		•						•		•
Luna Panna	•		•						•		•
Luna White	•		•						•		•
Mandorla Bronzo	•		•						•		•
Mandorla Greige	•		•						•		•
Mandorla Luce	•		•						•		•
Mandorla Panna	•		•						•		•
Mandorla White	•		•						•		•
Multishapes Black	•		•						•		•
Multishapes Bronzo	•		•						•		•
Multishapes Silver	•		•								
Multishapes Smoke	•		•						•		•
Multishapes White	•		•						•		•
Multishapes White Gloss	•		•						•		•
Origami White Gloss	•		•						•		•
Origami Black	•		•						•		•
Origami Bronzo	•		•						•		•
Origami Gold	•		•								
Origami Smoke	•		•						•		•
Origami White	•		•						•		•

											
Shapes Black	•		•						•		•
Shapes Bronzo	•		•						•		•
Shapes Greige	•		•						•		•
Shapes Luce	•		•						•		•
Shapes Panna	•		•						•		•
Shapes Smoke	•		•						•		•
Shapes White	•		•						•		•
Shapes White Gloss	•		•						•		•
Stripes Bamboo	•		•						•		•
Stripes Calacatta	•		•						•		•
Stripes Copper	•		•						•		•
Stripes Denim	•		•						•		•
Stripes Glacier	•		•						•		•
Stripes Linen	•		•						•		•
Stripes Mercury	•		•						•		•
Stripes Mix Bamboo	•		•						•		•
Stripes Mix Calacatta	•		•						•		•
Stripes Mix Copper	•		•						•		•
Stripes Mix Denim	•		•						•		•
Stripes Mix Glacier	•		•						•		•
Stripes Mix Linen	•		•						•		•
Stripes Mix Mercury	•		•						•		•
Stripes Mix Oak	•		•						•		•
Stripes Mix Teak	•		•						•		•
Stripes Oak	•		•						•		•
Stripes Teak	•		•						•		•
Transverse 1 Cement	•	•	•						•	•	•
Transverse 1 Clay	•	•	•						•	•	•
Transverse 1 Graphite	•	•	•						•	•	•
Transverse 1 Metal	•	•	•						•		•
Transverse 2 Cement	•	•	•						•	•	•
Transverse 2 Clay	•	•	•						•	•	•
Transverse 2 Crackle	•	•	•						•		•
Transverse 2 Graphite	•	•	•						•	•	•
Transverse 3 Cement	•	•	•						•	•	•
Transverse 3 Clay	•	•	•						•	•	•
Transverse 3 Graphite	•	•	•						•	•	•
Transverse 3 Wood	•	•	•						•	•	•
Transverse 4 Cement	•	•	•						•	•	•
Transverse 4 Clay	•	•	•						•	•	•
Transverse 4 Copper	•	•	•						•	•	•
Transverse 4 Graphite	•	•	•						•	•	•
Transverse 4 Luce	•	•	•						•	•	•



pieza/m2  
sqm/piece  
**м2/штуки**  
m2/pièce  
m2/pezzo  
m2/peça  
m²/Stück  
平方/片  
قطعة/m²



piezas/caja  
pieces/box  
**штук/коробка**  
pièces/carton  
pezzi/scatola  
peças/caixa  
Stück/Schachtel  
片/盒  
قطعة/الكرتون  
szt /w paczkach

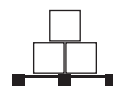

cajas/pallet  
boxes/pallet  
**коробки/паллет**  
cartons/palettes  
scatole/pallet  
Caixas/paleta  
Schachteln/Palette  
盒/栈板  
كرتون / اللوحه  
ilość paczek/w palecie



kg/caja  
Kg/box  
**кг/коробка**  
kg/carton  
kg/scatola  
Kg/caixa  
Kg/Schachtel  
千克/盒  
وزن الكرتون / بالكيلو غرام  
waga/paczki



libras/caja  
Lbs/box  
**фунты/коробка**  
livre/carton  
lb/scatola  
Libras/caixa  
Lbs/Schachtel  
磅/盒  
**وزن الكرتون/Lbs**  
szt/paczki



m2/caja  
sqm/box  
**м2/коробка**  
m2/carton  
m2/scatola  
m2/caixa  
m²/Schachteln  
平方/盒  
**كرتون/m²**  
mq/paczki



m2/pallet  
sqm/pallet  
**м2/паллет**  
m2/palette  
m2/pallet  
m2/paleta  
m²/Palette  
平方/栈板  
**اللوحه/m²**  
mq/palecie



# Tabla Embalajes / Packaging List

Aria Bronzo	16,00	8	9,60	21,16	60	0,50	30,00
Aria Greige	16,00	8	9,60	21,16	60	0,50	30,00
Aria Luce	16,00	8	9,60	21,16	60	0,50	30,00
Aria Panna	16,00	8	9,60	21,16	60	0,50	30,00
Aria White	16,00	8	9,60	21,16	60	0,50	30,00
Bivio Bronzo	16,00	10	12,50	27,56	60	0,63	37,50
Bivio Greige	16,00	10	12,50	27,56	60	0,63	37,50
Bivio Luce	16,00	10	12,50	27,56	60	0,63	37,50
Bivio Panna	16,00	10	12,50	27,56	60	0,63	37,50
Bivio White	16,00	10	12,50	27,56	60	0,63	37,50
Japan Black	16,00	8	9,66	21,31	60	0,50	30,00
Japan Bronzo	16,00	8	9,91	21,85	60	0,50	30,00
Japan Gold	16,00	8	10,38	22,88	60	0,50	30,00
Japan Smoke	16,00	8	10,12	22,31	60	0,50	30,00
Japan White	16,00	8	9,91	21,85	60	0,50	30,00
Japan White Gloss	16,00	8	10,14	22,35	60	0,50	30,00
Kioto Black	16,00	8	10,24	22,58	60	0,50	30,00
Kioto Bronzo	16,00	8	9,73	21,45	60	0,50	30,00
Kioto Silver	16,00	8	9,97	21,98	60	0,50	30,00
Kioto Smoke	16,00	8	9,92	21,87	60	0,50	30,00
Kioto White	16,00	8	9,73	21,45	60	0,50	30,00
Kioto White Gloss	16,00	8	9,91	21,85	60	0,50	30,00
Luna Bronzo	16,00	10	11,00	24,25	60	0,63	37,50
Luna Greige	16,00	10	11,00	24,25	60	0,63	37,50
Luna Luce	16,00	10	11,00	24,25	60	0,63	37,50
Luna Panna	16,00	10	11,00	24,25	60	0,63	37,50
Luna White	16,00	10	11,00	24,25	60	0,63	37,50
Mandorla Bronzo	16,00	8	9,84	21,69	60	0,50	30,00
Mandorla Greige	16,00	8	9,84	21,69	60	0,50	30,00
Mandorla Luce	16,00	8	9,84	21,69	60	0,50	30,00
Mandorla Panna	16,00	8	9,84	21,69	60	0,50	30,00
Mandorla White	16,00	8	9,84	21,69	60	0,50	30,00
Multishapes Black	16,00	8	8,73	19,24	60	0,50	30,00
Multishapes Bronzo	16,00	8	9,01	19,86	60	0,50	30,00
Multishapes Silver	16,00	8	9,32	20,55	60	0,50	30,00
Multishapes Smoke	16,00	8	8,82	19,44	60	0,50	30,00
Multishapes White	16,00	8	9,01	19,86	60	0,50	30,00
Multishapes White Gloss	16,00	8	9,10	20,07	60	0,50	30,00
Origami White Gloss	16,00	8	9,18	20,25	60	0,50	30,00
Origami Black	16,00	8	9,58	21,11	60	0,50	30,00
Origami Bronzo	16,00	8	9,78	21,57	60	0,50	30,00
Origami Gold	16,00	8	9,30	20,51	60	0,50	30,00
Origami Smoke	16,00	8	9,50	20,95	60	0,50	30,00
Origami White	16,00	8	9,78	21,57	60	0,50	30,00

Shapes Black	16,00	16	15,04	33,16	60	1,00	60,00
Shapes Bronzo	16,00	16	15,36	33,86	60	1,00	60,00
Shapes Greige	16,00	16	15,36	33,86	60	1,00	60,00
Shapes Luce	16,00	16	14,56	32,10	60	1,00	60,00
Shapes Panna	16,00	16	15,36	33,86	60	1,00	60,00
Shapes Smoke	16,00	16	14,88	32,80	60	1,00	60,00
Shapes White	16,00	16	15,84	34,92	60	1,00	60,00
Shapes White Gloss	16,00	16	15,71	34,64	60	1,00	60,00
Stripes Bamboo	16,00	14	13,72	30,25	60	0,88	52,50
Stripes Calacatta	16,00	14	13,72	30,25	60	0,88	52,50
Stripes Copper	16,00	14	13,72	30,25	60	0,88	52,50
Stripes Denim	16,00	14	13,72	30,25	60	0,88	52,50
Stripes Glacier	16,00	14	13,72	30,25	60	0,88	52,50
Stripes Linen	16,00	14	13,72	30,25	60	0,88	52,50
Stripes Mercury	16,00	14	13,72	30,25	60	0,88	52,50
Stripes Mix Bamboo	16,00	14	13,72	30,25	60	0,88	52,50
Stripes Mix Calacatta	16,00	14	13,72	30,25	60	0,88	52,50
Stripes Mix Copper	16,00	14	13,72	30,25	60	0,88	52,50
Stripes Mix Denim	16,00	14	13,72	30,25	60	0,88	52,50
Stripes Mix Glacier	16,00	14	13,72	30,25	60	0,88	52,50
Stripes Mix Linen	16,00	14	13,72	30,25	60	0,88	52,50
Stripes Mix Mercury	16,00	14	13,72	30,25	60	0,88	52,50
Stripes Mix Oak	16,00	14	13,72	30,25	60	0,88	52,50
Stripes Mix Teak	16,00	14	13,72	30,25	60	0,88	52,50
Stripes Oak	16,00	14	13,72	30,25	60	0,88	52,50
Stripes Teak	16,00	14	13,72	30,25	60	0,88	52,50
Transverse 1 Cement	46,28	42	19,74	43,52	70	0,91	63,53
Transverse 1 Clay	46,28	42	19,74	43,52	70	0,91	63,53
Transverse 1 Graphite	46,28	42	19,74	43,52	70	0,91	63,53
Transverse 1 Metal	46,28	42	18,06	39,82	70	0,91	63,53
Transverse 2 Cement	46,28	38	16,91	37,28	70	0,82	57,48
Transverse 2 Clay	46,28	38	16,91	37,28	70	0,82	57,48
Transverse 2 Crackle	46,28	38	17,10	37,70	70	0,82	57,48
Transverse 2 Graphite	46,28	38	16,91	37,28	70	0,82	57,48
Transverse 3 Cement	46,28	36	15,84	34,92	70	0,78	54,45
Transverse 3 Clay	46,28	36	15,84	34,92	70	0,78	54,45
Transverse 3 Graphite	46,28	36	15,84	34,92	70	0,78	54,45
Transverse 3 Wood	46,28	36	16,20	35,71	70	0,78	54,45
Transverse 4 Cement	46,28	41	17,63	38,87	70	0,89	62,02
Transverse 4 Clay	46,28	41	17,63	38,87	70	0,89	62,02
Transverse 4 Copper	46,28	38	16,34	36,02	70	0,82	57,48
Transverse 4 Graphite	46,28	41	17,63	38,87	70	0,89	62,02
Transverse 4 Luce	46,28	41	17,63	38,87	70	0,89	62,02

# DUNE

## Red Internacional / World Network

### ARGENTINA

Tel.: +54 114 6362568  
Fax: +54 114 6740135  
administracion@duneargentina.com.ar  
José Bonifacio, 3844  
C1407 HEL Buenos Aires

### AUSTRALIA

Tel.: +61 2 97710622  
Fax: +61 2 97710623  
decoration@dune.com.au  
Unit 2/203 Rookwood Road,  
Chullora NSW 2190

### BRASIL

TEL: (47) 3349-2921  
contato@dunebrasil.com.br  
Avenida dos estados, nº 4770  
Bairro: Estados  
Casa hall offices - Sala 101  
Cep: 88.339-060 - Balneário camboriú- (SC)

### CHINA

Tel.: 021-6271 3235 / 021-6271 3237  
contact@duneceramics.cn  
Room 302, No.71 Xi Su Zhou Lu, Jing An,  
200041, Shanghai  
上海市静安区西苏州路71号302室,  
邮编: 200041

### ESPAÑA - Oficinas Centrales/Headquarters

Tel.:+(34) 964 657 400  
Fax:+(34) 964 657 401  
dune@dune.es  
Partida Rachina s/n, 12130  
San Juan de Moró(Castellón)-Spain

### FRANCE

Tel.: +33 474064808  
Fax: +33 474064807  
dune@svs.fr  
ZI Visionis, 2, 11-12  
Rue du développement  
01090 Guereins

### MEXICO

Tel./Fax: +52(55) 53004576  
ventas@dune.com.mx  
Sevilla 821 - Col. Portales Sur  
Delegación Benito Juárez  
México DF C.P. 03300

### PORTUGAL

Tel.: +351 261430070  
Fax: +351 261430079  
gamauno@gamauno.pt  
Rua da Cruz, 86  
2565-031 Campelos  
Torres Vedras

### UNITED KINGDOM

Tel: +44 1455610202  
Fax:+44 1455610216  
sales@duneuk.co.uk  
UNIT 2 - Sketchley Meadows  
LE10 3EN Hinckley

### USA - CALIFORNIA

Tel.: +1 310 6086880  
Fax: +1 310 6086890  
california@duneusa.com  
1410 Kona Drive  
Rancho Domínguez, CA 90220

### USA - FLORIDA

Tel.: 1800-9538631  
Fax: 1888-6083890  
florida@duneusa.com  
2302 Vinson Lane, Unit 2  
Jacksonville, FL 32207



*Spanish Design*

© Copyright DUNE CERAMICA S.L. Reservados todos los derechos.  
Catálogo Shapes - Octubre 2017  
Impresión: Mare Nostrum

Dune Cerámica se reserva el derecho de modificar las características de sus productos sin preaviso de ningún tipo.  
Los acabados se dan a título indicativo, quedando bajo reserva los ajustes de los colores consecuencia de las técnicas de impresión.  
Por ello, las fotografías de los productos expuestos no son contractuales.  
La interpretación de las ilustraciones estará en función del criterio del creador.  
Los textos que aparecen en el catálogo quedan bajo reserva de posible error por composición o inserción de página.  
Este catálogo es meramente informativo.

© Copyright DUNE CERAMICA S.L. All rights reserved.  
Shapes Catalogue - October 2017  
Printed by Mare Nostrum

Dune Cerámica reserves the right to change the characteristics of its products without prior notice.  
Information about the finishes of the goods is only provided as a guide.  
As a result of the printing techniques, there might be differences between the colours printed in this catalogue and those of the real products.  
Colours shown in this catalogue are not contractual.  
The images are for illustration purposes only and are subject to the designers interpretation.  
This catalogue is for information purposes only.





SHAPES  
by  
DUNE

# SHAPES

by

# DUNE



Diseña tus ambientes 3D en / *Design your 3D settings on:*  
[www.dune.es](http://www.dune.es)



ESPAÑA - Oficinas Centrales/Headquarters  
Partida Rachina s/n, 12130 - San Juan de Moró(Castellón) - Spain  
Tel.:+(34) 964 657 400 - Fax:+(34) 964 657 401  
[dune@dune.es](mailto:dune@dune.es) - [www.dune.es](http://www.dune.es)